

*Superior Quality Instruments*

DENTAL  
INSTRUMENTS  
CATALOGUE

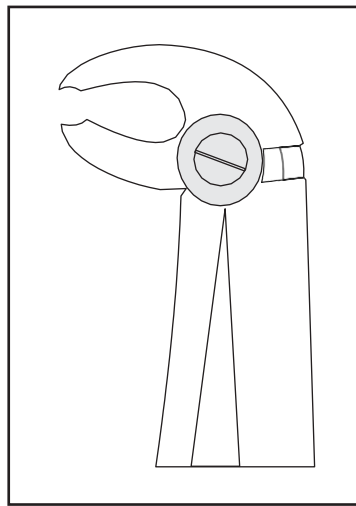



**Dental Forceps-English Pattern**  
**Daviers-Modèle anglais**  
**Zahnzangen-Englische Form**



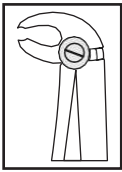

Upper incisors and bicuspid  
 Incisives et canines supérieures  
 Obere schneide-und eckzähne



Fig. 1  
 11-001-001

Upper incisors and bicuspid  
 Incisives et canines supérieures  
 Obere schneide-und eckzähne



Fig. 2  
 11-001-002

Upper incisors and bicuspid  
 Incisives et canines supérieures  
 Obere schneide-und eckzähne

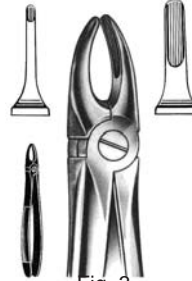

Fig. 3  
 11-001-003

Lower incisors and bicuspid  
 Incisives et canines inférieures  
 Untere schneide-und eckzähne



Fig. 4  
 11-001-004

Upper Premolars  
 Prémolaires supérieures  
 Obere prämolaren

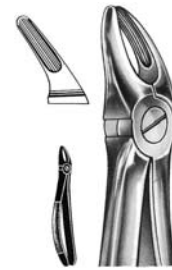

Fig. 7  
 11-001-007

Lower Premolars  
 Prémolaires inférieures  
 Untere prämolaren



Fig. 13  
 11-013-000

Upper molars, right  
 Molaires supérieures, droites  
 Obere molaren, rechts



Fig. 17  
 11-017-000

Lower Premolars  
 Prémolaires inférieures  
 Untere prämolaren



Fig. 8  
 11-008-000

Upper molars, left  
 Molaires supérieures, gauches  
 Obere molaren, links

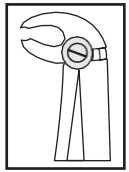

Fig. 18  
 11-018-000

Upper molars  
 molaires supérieures  
 Obere molaren



Fig. 18A  
 11-018-001



Upper wisdom  
 Dents de sagesse supérieures  
 Obere weisheitszähne



Fig. 19  
 11-019-000

Lower wisdom  
 Dents de sagesse inférieures  
 Untere weisheitszähne

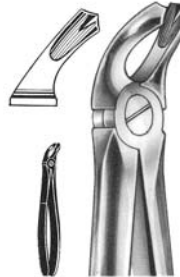

Fig. 20  
 11-020-000

Lower molars  
 Molaires inférieures  
 Untere molaren

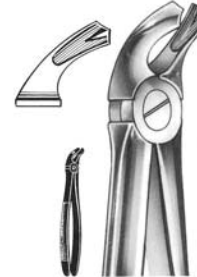

Fig. 21  
 11-021-000

Lower molars  
 Molaires inférieures  
 Untere molaren



Fig. 22  
 11-022-000

Lower molars  
 Molaires inférieures  
 Untere molaren



Fig. 22A  
 11-022-001

Lower Premolars, and molars  
 Prémolaires et molaires inférieures  
 Untere prämolaren und molaren



Fig. 22S  
 11-022-003

Lower molars, right  
 Molaires inférieures, droites  
 Untere molaren, rechts



Fig. 23  
 11-023-000

Lower molars  
 Molaires inférieures  
 Untere molaren



Fig. 22G  
 11-022-002

Lower molars, left  
 Molaires inférieures, gauches  
 Untere molaren, links



Fig. 24  
 11-024-000

Upper incisors and roots  
 Incisives et racines supérieures  
 Obere schneidezähne und wurzein



Fig. 29  
 11-029-000



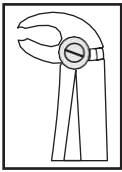

Upper incisors, bicusps and roots  
 Incisives, canines et racines supérieures  
 Obere Schneide, Eckzähne und Wurzeln

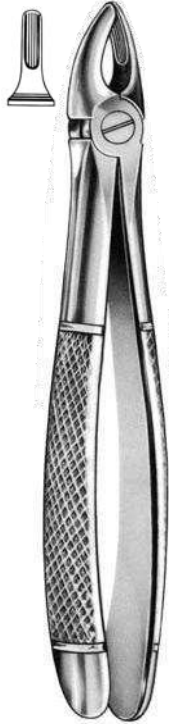

Fig. 29S  
 11-029-001

Upper roots  
 Racines supérieures  
 Obere Wurzeln



Fig. 30  
 11-030-000

Lower roots  
 Racines inférieures  
 Untere Wurzeln



Fig. 31  
 11-031-000

Lower molars  
 Molaire inférieures  
 Untere Molaren



Fig. 32  
 11-032-000

Lower roots  
 Racines inférieures  
 Untere Wurzeln



Fig. 33  
 11-033-000

Lower roots  
 Racines inférieures  
 Untere Wurzeln



Fig. 33A  
 11-033-001

Lower roots  
 Racines inférieures  
 Untere Wurzeln



Fig. 33B  
 11-033-002

Lower roots  
 Racines inférieures  
 Untere Wurzeln

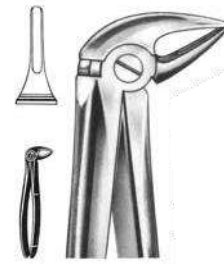

Fig. 33L  
 11-033-003

Lower roots  
 Racines inférieures  
 Untere Wurzeln



Fig. 33M  
 11-033-004

Lower roots  
 Racines inférieures  
 Untere Wurzeln

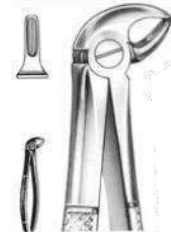
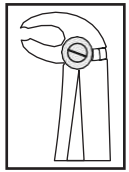
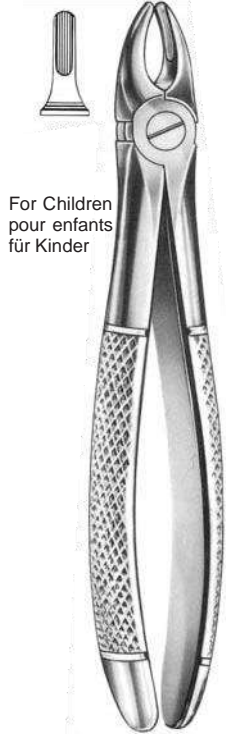

Fig. 33S  
 11-033-005



Upper incisors and bicuspid  
Incisives et canines supérieures  
Obere schneide-und eckzähne



For Children  
pour enfants  
für Kinder

Fig. 37  
11-037-000

Lower incisors and bicuspid  
Incisives et canines inférieures  
Untere schneide-und eckzähne



For Children  
pour enfants  
für Kinder

Fig. 38  
11-038-000

Upper Premolars, and molars  
Prémolaires et molaires supérieures  
Obere prämolaren und molaren



For Children  
pour enfants  
für Kinder

Fig. 39  
11-039-000

Lower molars  
Molaires inférieures  
Untere molaren



For Children  
pour enfants  
für Kinder

Fig. 40  
11-040-000

Upper roots  
Racines supérieures  
Obere wurzein



Fig. 41  
11-041-000

Upper roots  
Racines supérieures  
Obere wurzein



Fig. 44  
11-044-000

Lower roots  
Racines inférieures  
Untere wurzein



Fig. 45  
11-045-000

Upper roots  
Racines supérieures  
Obere wurzein



Fig. 51  
11-051-000

Upper roots  
Racines supérieures  
Obere wurzein



Fig. 51A  
11-051-001

Upper roots  
Racines supérieures  
Obere wurzein



Fig. 51L  
11-051-002



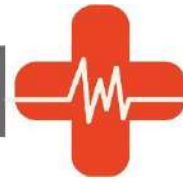
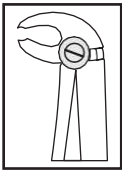

Upper roots  
 Racines supérieures  
 Obere wurzein

Slender Jaw  
 mors délicats  
 schlankes Maul

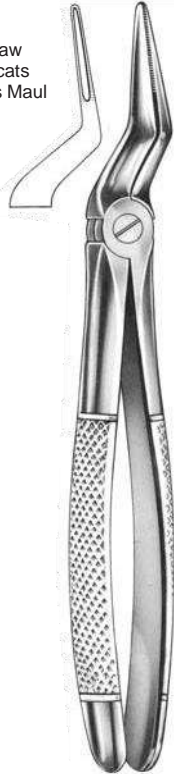

Fig. 51L  
 11-051-003

Upper roots  
 Racines supérieures  
 Obere wurzein



Fig. 51S  
 11-051-004

For Children  
 pour enfants  
 für Kinder

Upper roots  
 Racines supérieures  
 Obere wurzein



Fig. 52  
 11-052-000

Splitting forceps for roots of  
 Upper molars  
 Daviers a crevasser les racines des  
 molares supérieures  
 Spaltzange für obere molarwurzeln

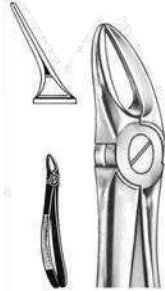

Fig. 55  
 11-055-000

Splitting forceps for roots of  
 lower molars  
 Daviers a crevasser les racines des  
 molares inférieures  
 Spaltzange für untere molarwurzeln

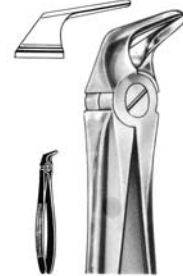

Fig. 56  
 11-056-000

Upper wisdoms  
 Dents de sagesse supérieures  
 Obere weisheitszähne



Fig. 67  
 11-067-000

Upper wisdoms  
 Dents de sagesse supérieures  
 Obere weisheitszähne

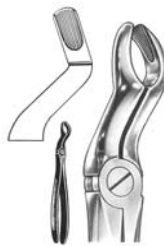

Fig. 67a  
 11-067-001

Lower roots  
 Pacines inférieures  
 Untere wurzein



Ryding  
 Fig. 68  
 11-068-000

Lower roots  
 Pacines inférieures  
 Untere wurzein



Hare  
 Fig. 68a  
 11-068-001

Lower molars  
 Molaires inférieures  
 Untere molaren



Fig. 73  
 11-073-000

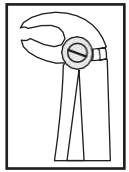

Lower roots incisors and bicuspid  
Racines, incisives et canines inférieures  
Utere wurzln schneide-und eckzähne



**Fig. 74**  
**11-074-000**

Lower roots incisors and bicuspid  
Racines, incisives et canines inférieures  
Utere wurzln schneide-und eckzähne



**Fig. 74D**  
**11-074-001**

Lower roots incisors and bicuspid  
Racines, incisives et canines inférieures  
Utere wurzln schneide-und eckzähne



**Fig. 74N**  
**11-074-002**

Lower Premolars  
Prémolaires inférieures  
Untere prämolaren



**Fig. 75**  
**11-075-000**

Upper roots  
Racines supérieures  
Obere wurzein



**Fig. 76**  
**11-076-000**

Upper roots  
Racines supérieures  
Obere wurzein

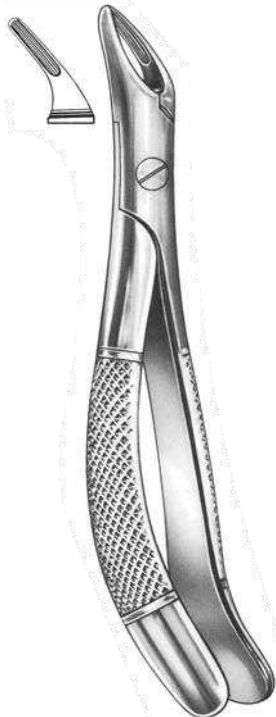

**Read**  
**Fig. 76N**  
**11-076-001**

Lower wisdom  
Dents de sagesse inférieures  
Untere weisheitszähne



**Fig. 79**  
**11-079-000**

Lower wisdom  
Dents de sagesse inférieures  
Untere weisheitszähne

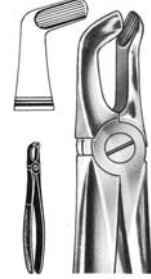

**Fig. 79A**  
**11-079-001**

Lower molars  
Molaires inférieures  
Untere molaren



**Fig. 86A**  
**11-086-001**

Lower molars  
Molaires inférieures  
Untere molaren



**Fig. 86B**  
**11-086-002**



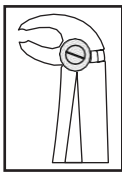

Lower molars  
Molaires inférieures  
Untere molaren



**Fig. 86C**  
**11-086-003**

Lower molars  
Molaires inférieures  
Untere molaren



**Fig. 87**  
**11-087-000**

Upper molars, right  
Molaires supérieures, droites  
Obere molaren, rechts



**Fig. 89**  
**11-089-000**

Upper molars, left  
Molaires supérieures, gauches  
Obere molaren, links



**Fig. 90**  
**11-090-000**

Upper molars, right  
Molaires supérieures, droites  
Obere molaren, rechts

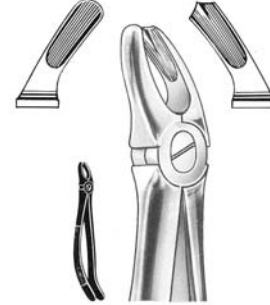

**Fig. 94**  
**11-094-000**

Upper molars, right  
Molaires supérieures, droites  
Obere molaren, rechts

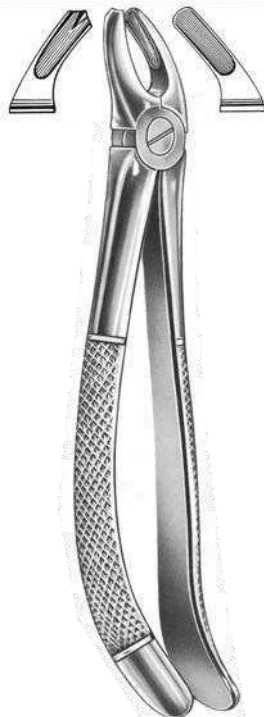

**Fig. 95**  
**11-095-000**

Lower molars  
Molaires inférieures  
Untere molaren



**Wood**  
**Fig. 99**  
**11-099-000**

Upper roots and premolars  
Recines et prémolaires supérieures  
Obere wurzeln undprämolaren



**Fig. 101**  
**11-101-000**

Upper roots and premolars  
Recines et prémolaires supérieures  
Obere wurzeln undprämolaren

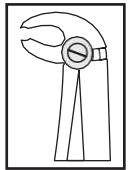

**Fig. 101A**  
**11-101-001**

Upper incisors and bicuspids  
Incisives et canines supérieures  
Obere schneide-und eckzähne



**Fig. 107**  
**11-107-000**



Upper roots  
 Racines supérieures  
 Obere wurzein

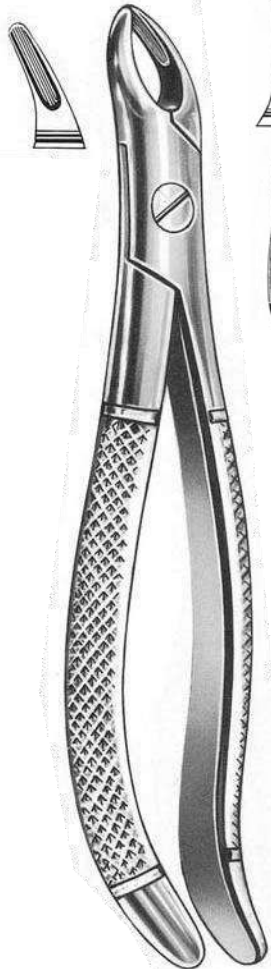

**Hill**  
 Fig. 108  
 11-108-000

Upper roots  
 Racines supérieures  
 Obere wurzein

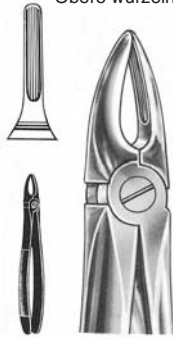

**Martin**  
 Fig. 113  
 11-113-000

Lower roots  
 Pacines inférieures  
 Untere wurzein

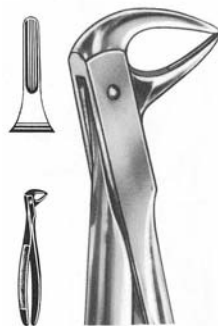

**Martin**  
 Fig. 114  
 11-114-000

Upper incisors and roots  
 Incisives et racines supérieures  
 Obere schneidezähne und wurzein

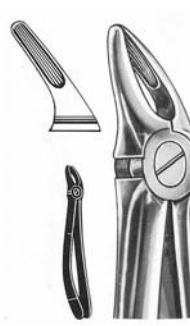

**Guy**  
 Fig. 136  
 11-136-000



**Guy**  
 Fig. 137  
 11-137-000

Upper incisors bicusps and premolars  
 Incisives et canines supérieures, prémolaires  
 Obere schneide-und eckzähne, prämolaren

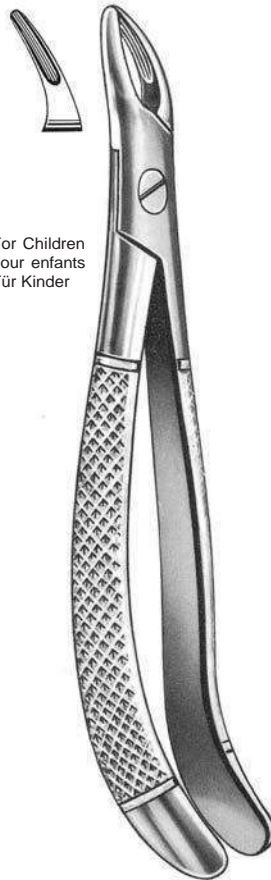

For Children  
 pour enfants  
 Für Kinder

**Hill**  
 Fig. 138  
 11-138-000

Lower roots  
 Pacines inférieures  
 Untere wurzein



**Coleman**  
 Fig. 143  
 11-143-000



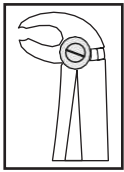

Lower molars and wisdom, left  
 Molaires et dents de sagesse inférieures, gauches  
 Untere molaren und weisheitszähne, links

Lower molars and wisdom, right  
 Molaires et dents de sagesse inférieures, droites  
 Untere molaren und weisheitszähne, rechts

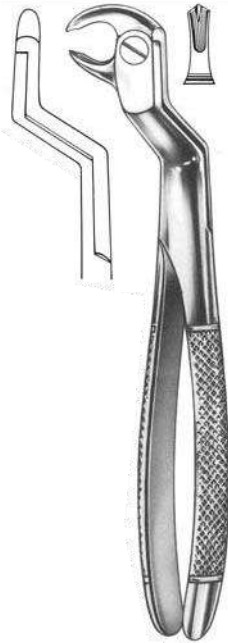

**Wisdom-Routurier**  
 Fig. 22½ L  
 11-150-225

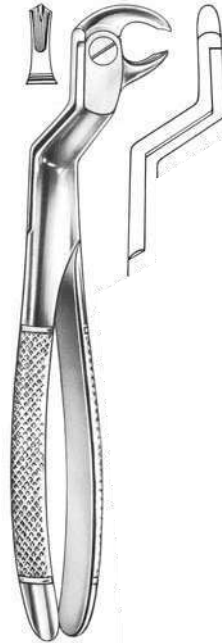

**Wisdom-Routurier**  
 Fig. 22½ R  
 11-151-225

**Dental Forceps “Mead”**  
**Daviers “Mead”**  
**Zahnzangen Modell “Mead”**

Upper incisors bicusps and roots  
 Incisives, canines et racines supérieures  
 Obere schneide, eckzähne und wurzeln

Upper molars  
 Molaires supérieures  
 Obere molaren

Lower roots incisors and bicusps  
 Racines, incisives et canines inférieures  
 Untere wurzeln, schneide-und eckzähne

Lower molars  
 Molaires inférieures  
 Untere molaren



**Mead**  
 Fig. MD 1  
 11-161-000



**Mead**  
 Fig. MD 2  
 11-162-000

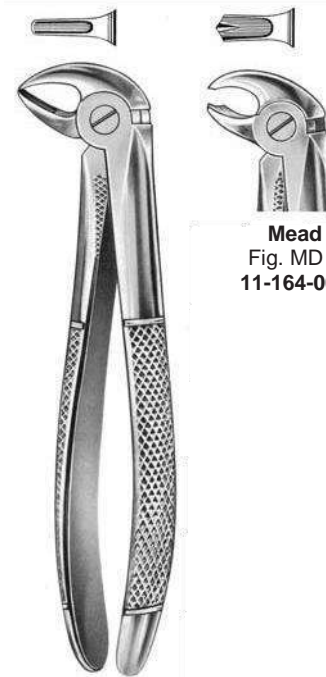

**Mead**  
 Fig. MD 3  
 11-163-000



**Mead**  
 Fig. MD 4  
 11-164-000



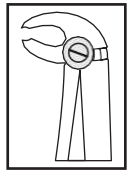

Upper wisdoms  
 Dents de sagesse supérieures  
 Obere weisheitszähne



**Felsch**  
 11-166-000

Universal  
 Universel  
 Universal



**Cohen**  
 11-170-000

Lower molars and wisdom  
 Molaires et dents de sagesse inférieures  
 Untere molaren und weisheitszähne



**Stiksa**  
 Fig. 1  
 11-172-001



**Stiksa**  
 Fig. 2  
 11-172-002

Upper roots  
 Racines supérieures  
 Obere wurzein



**Witzel**  
 11-180-001

Lower roots  
 Racines inférieures  
 Untere wurzein



**Witzel**  
 11-180-002



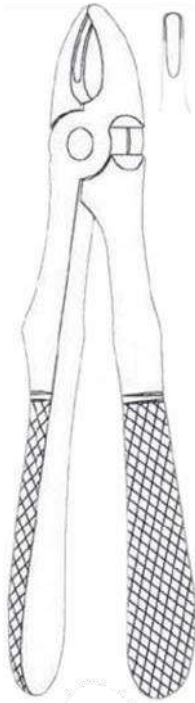
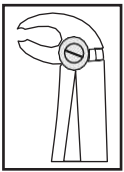

Fig 1  
11-181-001

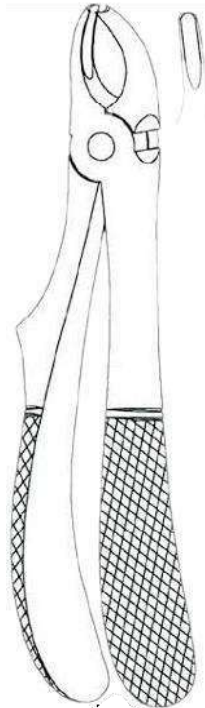

Fig 2  
11-181-002

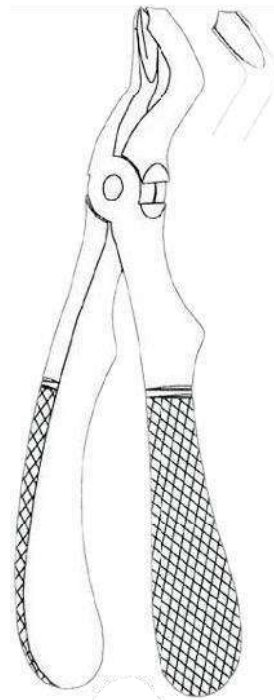

Fig 3  
11-181-003

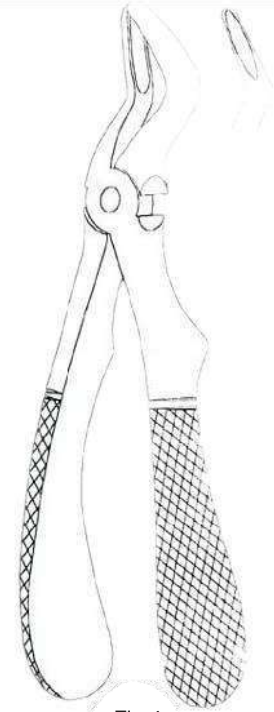

Fig 4  
11-181-004

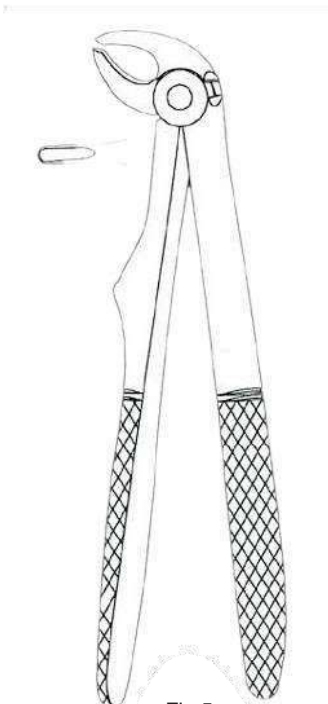

Fig 5  
11-181-005

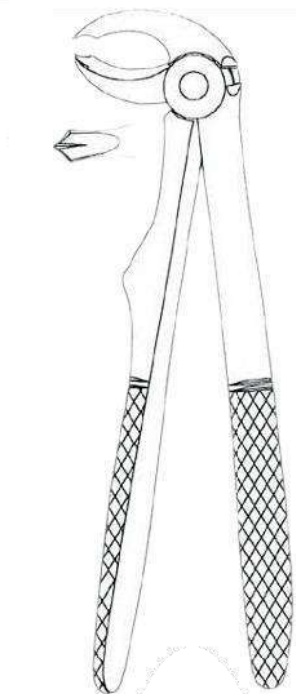

Fig 6  
11-181-006

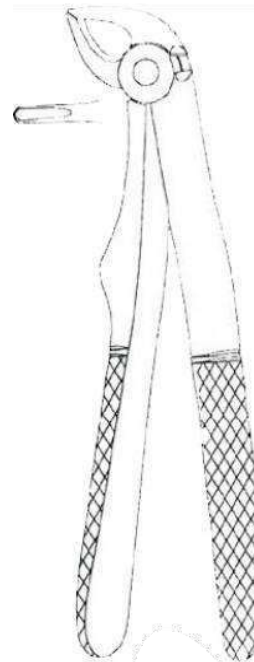
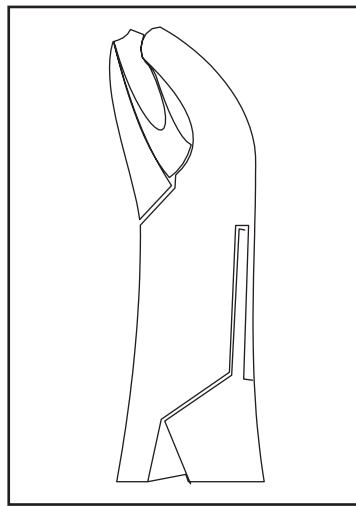

Fig 7  
11-181-007

**ALL KLIEN FORCEPS  
 ARE AVAILABLE  
 WITH AND  
 WITHOUT SPRINGS  
 Please specify in your Orders**



**Dental Forceps-American Pattern**  
**Daviers-Modèle américain**  
**Zahnzangen-amerikanische Form**



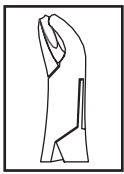

Upper incisors and bicusps  
 Incisives et canines supérieures  
 Obere schneide-und eckzähne



Fig. 1  
 13-001-000

Upper roots, anterior  
 Racines et canines supérieures  
 Obere wurzein, vorne



Fig. 1B  
 13-001-001

Lower wisdoms  
 Dents de sagesse inférieures  
 Untere weisheitszähne



Physick  
 Fig. 5  
 13-005-000

Lower molars, splitting forceps  
 Molaires inférieures, daviers pour separer des racines  
 Untere molaren, spaltzange



Fig. 6  
 13-006-000

Upper molars  
 Molaires supérieures  
 Obere molaren



Fig. 10H  
 13-010-001

Upper molars  
 Molaires supérieures  
 Obere molaren



Fig. 10S  
 13-010-002

Lower molars  
 Molaires inférieures  
 Untere molaren



Fig. 15  
 13-015-000

Lower molars  
 Molaires inférieures  
 Untere molaren



Fig. 16  
 13-016-000

Lower molars  
 Molaires inférieures  
 Untere molaren



Fig. 16S  
 13-016-001

For Children  
 pour enfants  
 für Kinder



Lower molars  
Molaires inférieures  
Untere molaren



Fig. 17  
13-017-000

Upper molars, left  
Molaires supérieures, gauches  
Obere molaren, links



Fig. 18L  
13-018-001

Upper molars, right  
Molaires supérieures, droites  
Obere molaren, rechts



Fig. 18R  
13-018-002

Lower molars  
Molaires inférieures  
Untere molaren



Fig. 23  
13-023-000

Upper molars  
Molaires supérieures  
Obere molaren



Fig. 24  
13-024-000

Upper premolars, and molars  
Prémolaires et molaires supérieures  
Obere prämolaren und molaren



Fig. 32  
13-032-000

Upper roots and premolars  
Recines et prémolaires supérieures  
Obere wurzeln und prämolaren



Fig. 32A  
13-032-001

Upper molars, left  
Molaires supérieures, gauches  
Obere molaren, links

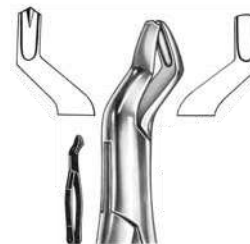

Fig. 53L  
13-053-001

Upper molars, right  
Molaires supérieures, droites  
Obere molaren, rechts



Fig. 53R  
13-053-002

Upper tooth, roots, temporary teeth  
Dents, racines et denture temporaire supérieures  
Obere zähne, wurzeln, milchzähne



Fig. 62  
13-062-000





**Dental Forceps-American Pattern**  
**Daviers, modèle américain**  
**Zahnzangen, amerikanische Form**



Upper incisors and roots  
 Incisives et racines supérieures  
 Obere schneidezähne und wurzeln



Fig. 65  
 13-065-000

Upper and lower roots  
 Racines supérieures et inférieures  
 Obere und untere wurzeln



Fig. 69  
 13-069-000

Lower bicuspid premolars, and molars  
 Canines, prémolaires et molaires inférieures  
 Untere eckzähne, prämolaren, molaren



Fig. 85  
 13-085-000

Lower bicuspid premolars, and molars  
 Canines, prémolaires et molaires inférieures  
 Untere eckzähne, prämolaren, molaren



Fig. 85A  
 13-085-001

Upper molars, left  
 Molaires supérieures, gauches  
 Obere molaren, links



Fig. 88L  
 13-088-001

Upper molars, right  
 Molaires supérieures, droites  
 Obere molaren, rechts



Fig. 88R  
 13-088-002

Upper incisors bicuspid and premolars  
 Incisives, et canines prémolaires supérieures  
 Obere schneide-und eckzähne prämolaren



Fig. 99A  
 13-099-001

Upper incisors bicuspid and premolars  
 Incisives, et canines prémolaires supérieures  
 Obere schneide-und eckzähne prämolaren



Fig. 99C  
 13-099-002

Upper bicuspid, premolars, temporary teeth  
 Canines prémolaires, denture temporaire supérieures  
 Obere eckzähne prämolaren, milchzähne

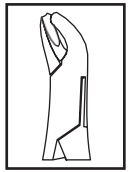

Fig. 101  
 13-101-000

Lower roots incisors and bicuspid  
 Racines, incisives et canines  
 Untere wurzeln, schneide-und eckzähne



Fig. 103  
 13-103-000



Upper incisors, premolars and roots  
 Incisives, prémolaires racines supérieures  
 Obere prämolaren schneidezähne, wurzeln



**Cryer**  
 Fig. 150  
 13-150-000

Upper incisors, premolars and roots  
 Incisives, prémolaires racines supérieures  
 Obere prämolaren schneidezähne, wurzeln



Fig. 150A  
 13-150-001

Upper incisors, premolars and roots  
 Incisives, prémolaires racines supérieures  
 Obere prämolaren schneidezähne, wurzeln



Fig. 150S  
 13-150-002

Lower incisors, premolars and roots  
 Incisives, prémolaires racines inférieures  
 Untere prämolaren schneidezähne, wurzeln



Fig. 151  
 13-151-000

Lower incisors, premolars and roots  
 Incisives, prémolaires racines inférieures  
 Untere prämolaren schneidezähne, wurzeln



Fig. 151A  
 13-151-001

Lower incisors, premolars and roots  
 Incisives, prémolaires racines inférieures  
 Untere prämolaren schneidezähne, wurzeln



Fig. 151S  
 13-151-002

Lower incisors, premolars and roots  
 Incisives, prémolaires racines inférieures  
 Untere prämolaren schneidezähne, wurzeln



Fig. 203  
 13-203-000

Upper wisdoms  
 Dents de sagasse supérieures  
 Obere weisheitszähne



Fig. 210  
 13-210-000

Upper wisdoms  
 Dents de sagasse supérieures  
 Obere weisheitszähne



Fig. 210S  
 13-210-001

Upper incisors, premolars and roots  
 Incisives, prémolaires racines supérieures  
 Obere prämolaren schneidezähne, wurzeln

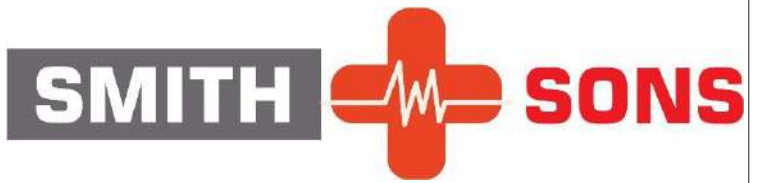

Fig. 213  
 13-213-000





**Dental Forceps-American Pattern**  
**Daviers, modèle américain**  
**Zahnzangen, amerikanische Form**



Lower wisdoms  
 Dents de sagesse inférieures  
 Untere weisheitszähne



Fig. 222  
 13-222-000

Lower incisors, premolars and roots  
 Incisives, prémolaires racines inférieures  
 Untere prämolaren schneidezähne, wurzeln

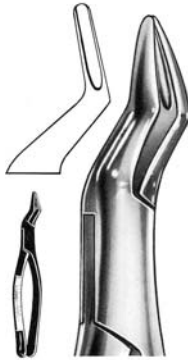

Fig. 286  
 13-286-000

Lower molars  
 Molaires inférieures  
 Untere molaren



Fig. 287  
 13-287-000

Lower bicusps and premolars  
 Canines, et prémolaires inférieures  
 Untere eckzähne, und prämolaren



Fig. 288  
 13-288-000

**Dental Forceps for Children - American Pattern**  
**Daviers - Daviers pour enfants - américain**  
**Foerps de Extraccion para ninos - amerikanische Form**

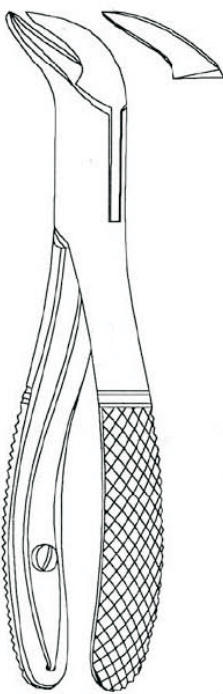

Fig. 23S  
 13-290-23S

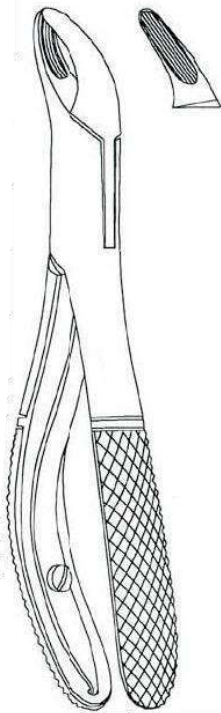

Fig. 150-1/2S  
 13-150-1/2S

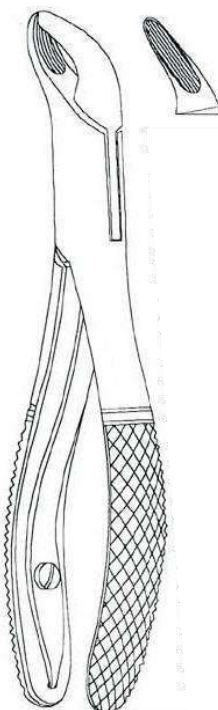

Fig. 151-1/2S  
 13-151-1/2S

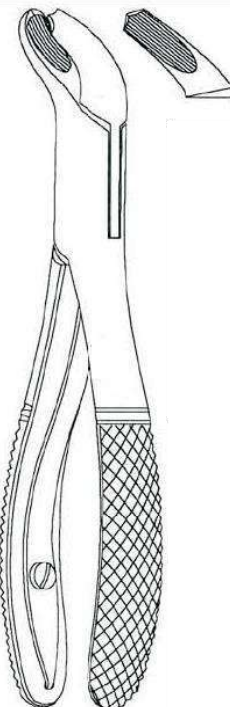

Fig. 17S  
 13-290-17S

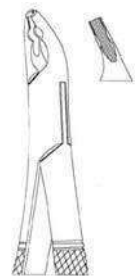

Fig. 150 XAS  
 13-150-XAS

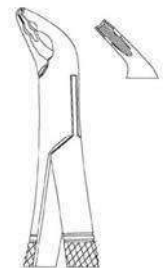
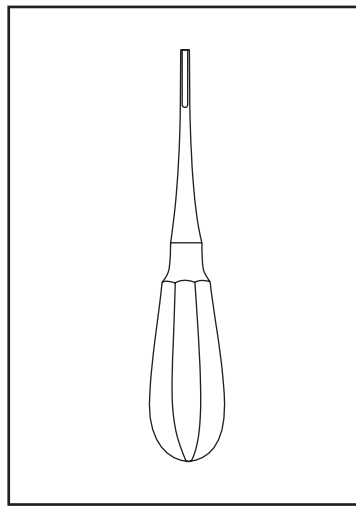
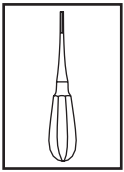

Fig. 151 XAS  
 13-151-XAS



**Root Elevators**  
**Elevadores à racines**  
**Wurzelheber**





**Root Elevators**  
Elevateurs à racines  
Wurzelheber



**Bein**

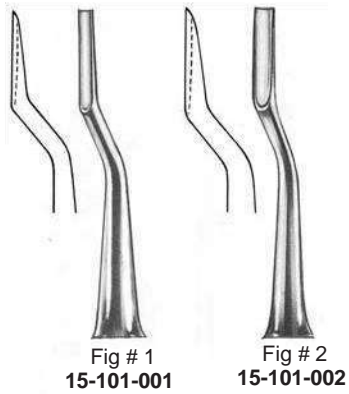
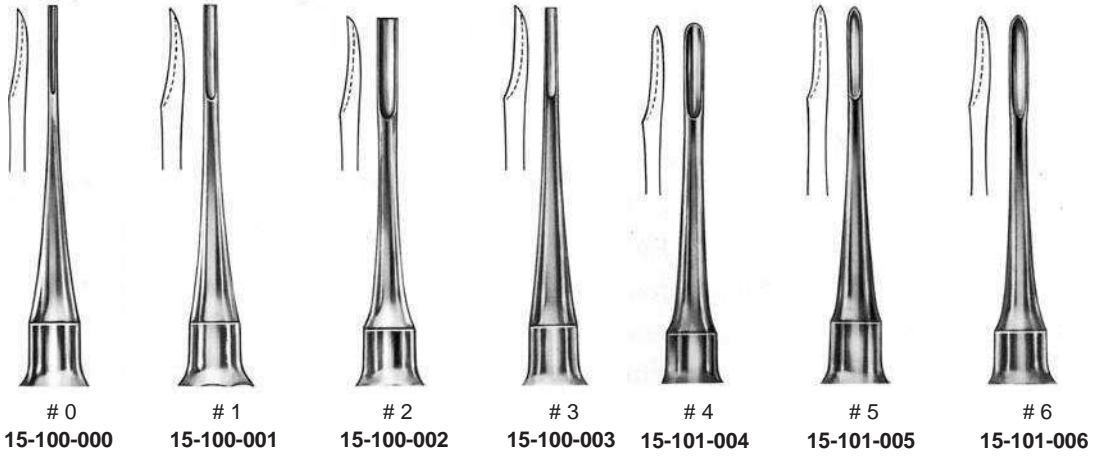

Fig # 1 15-101-001  
Fig # 2 15-101-002



**Bein**

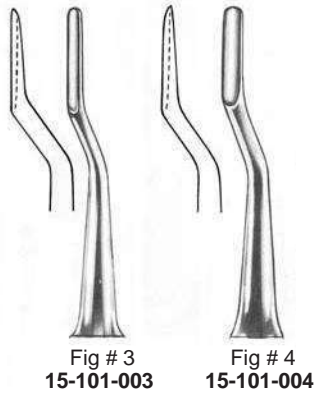

Fig # 3 15-101-003  
Fig # 4 15-101-004

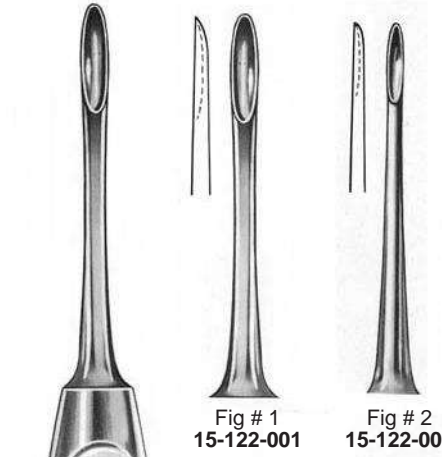
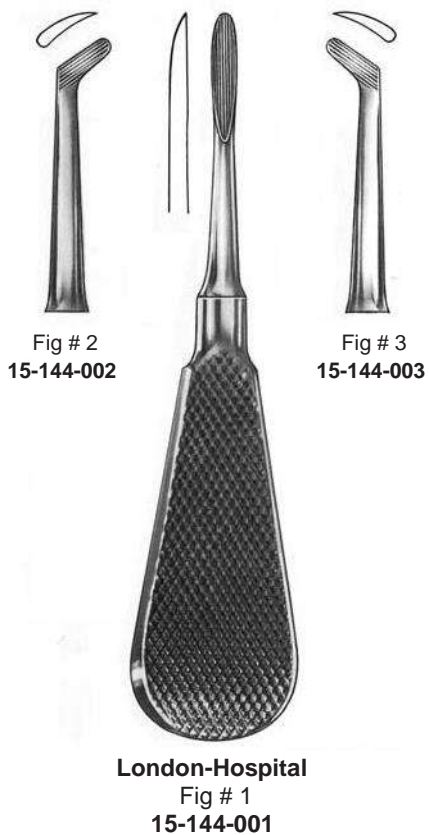
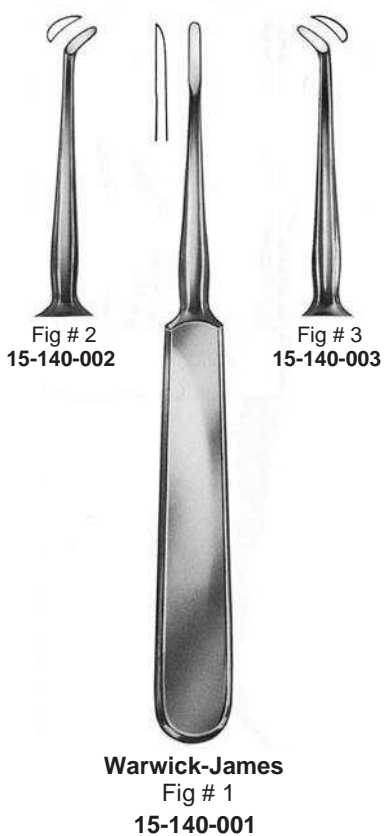
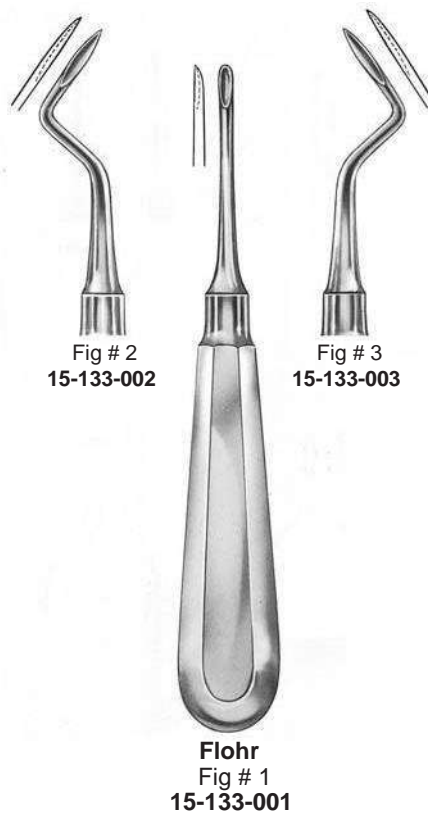
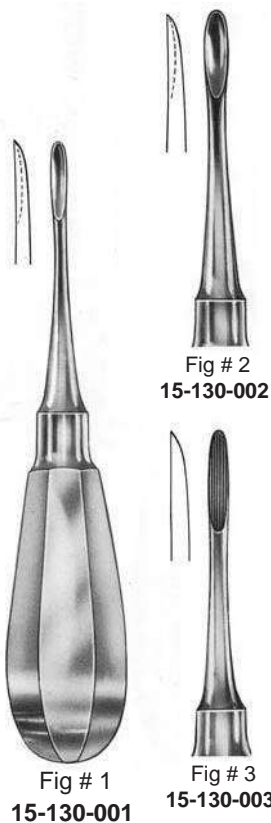
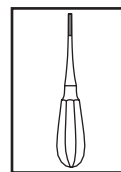
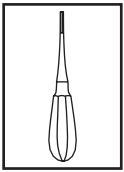

Fig # 1 15-122-001  
Fig # 2 15-122-002



**Hylin**





**Root Elevators**  
 Elevateurs à racines  
 Wurzelheber



**Kopp**



Fig # 1  
15-150-001



Fig # 2  
15-150-002



Fig # 3  
15-150-003



Fig # 4  
15-150-004

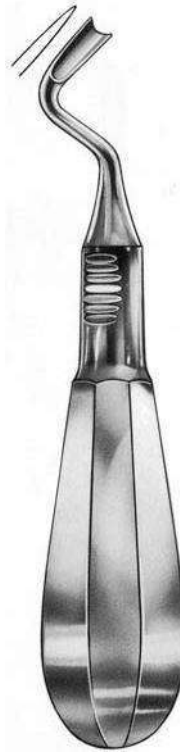

**Ott**  
15-155-000

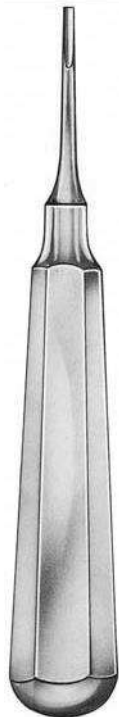

**Coupland**



Fig # 1  
15-210-001



Fig # 2  
15-210-002



Fig # 3  
15-210-003



Fig # 1  
15-215-001



**Cryer**



Fig # 2  
15-215-002

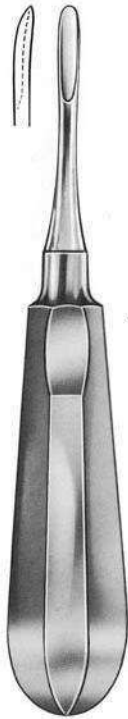
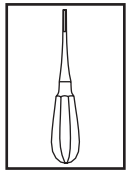
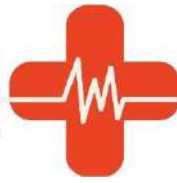

**Cryer**  
 Fig. 3  
 15-220-003



Fig. 4  
 15-220-004



Fig. 12  
 15-220-012



Fig. 27  
 15-220-027



Fig. 28  
 15-220-028



Fig. 27S  
 15-220-127



Fig. 28S  
 15-220-128



**Seldin**



Fig. 1L  
 15-225-001



Fig. 1R  
 15-225-011



Fig. 2  
 15-225-002



Fig. 3  
 15-225-003

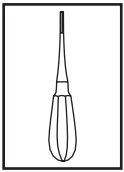

Fig. 4L  
 15-225-004



Fig. 4R  
 15-225-044





**Root Elevators**  
 Elevateurs à racines  
 Wurzelheber



**Apical**



**Fig. 1**  
15-230-001



**Fig. 2**  
15-230-002



**Fig. 3**  
15-230-003



**Fig. 4**  
15-230-004



**Fig. 1**  
15-245-001



**Fig. 2**  
15-245-002

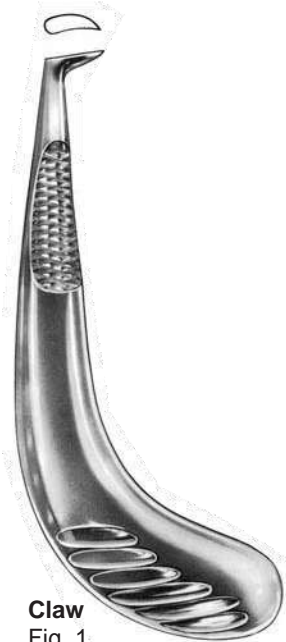

**Claw**  
**Fig. 1**  
15-241-001

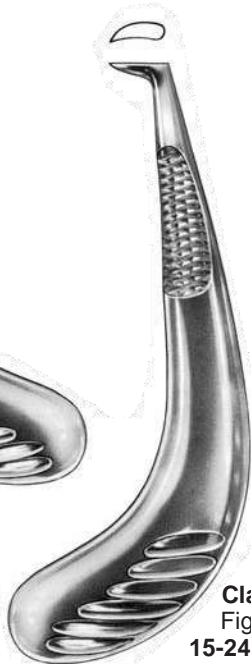

**Claw**  
**Fig. 2**  
15-241-002

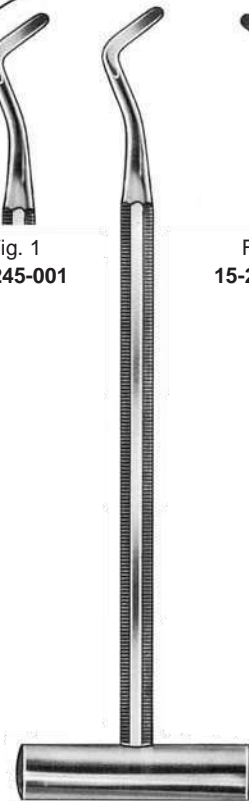

**Pott**

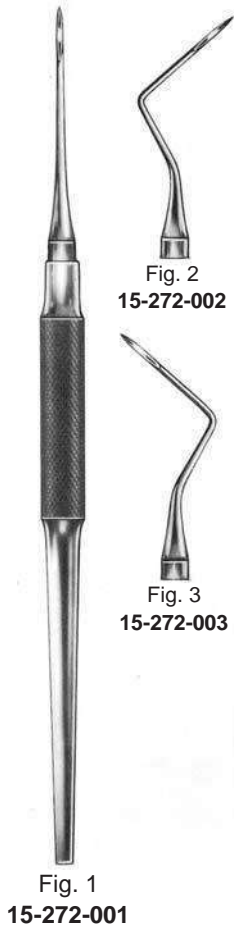
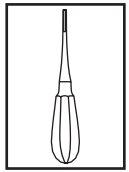

**Root Elevators**  
**Elevadores à racines**  
**Wurzelheber**

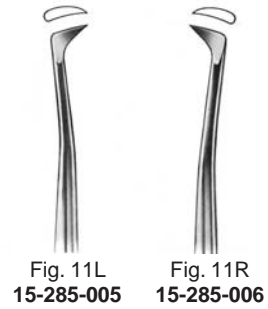
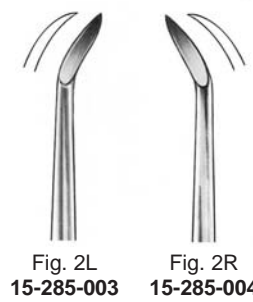
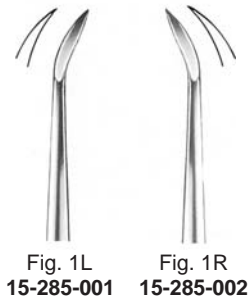
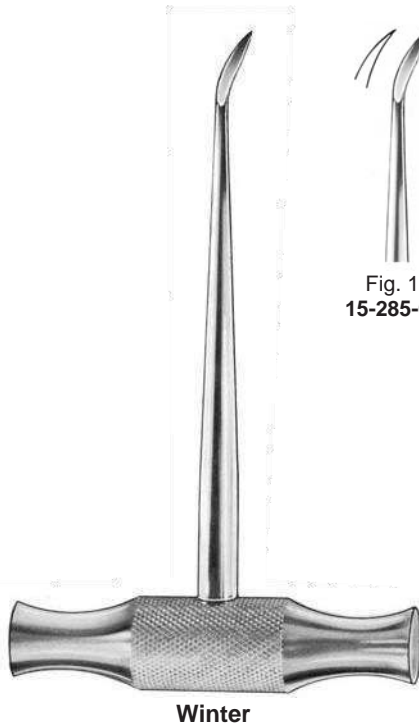

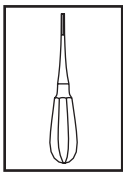

**Root Elevators**  
 Elevateurs à racines  
 Wurzelheber

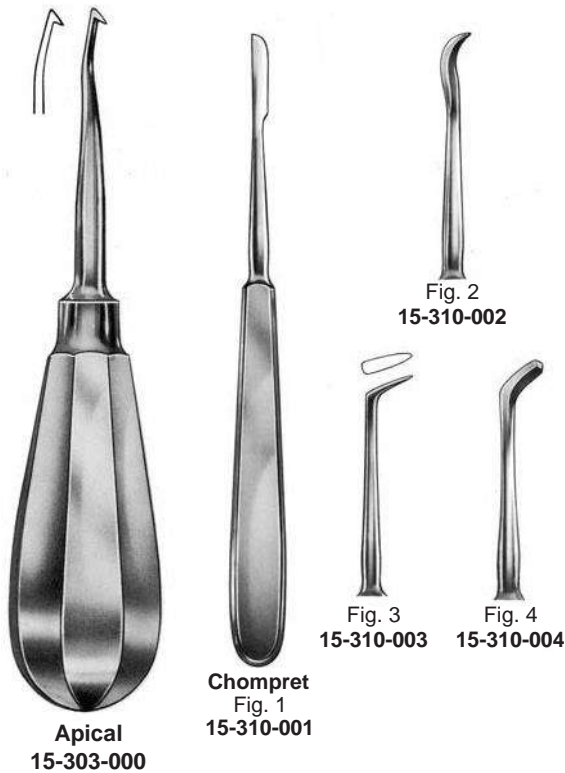
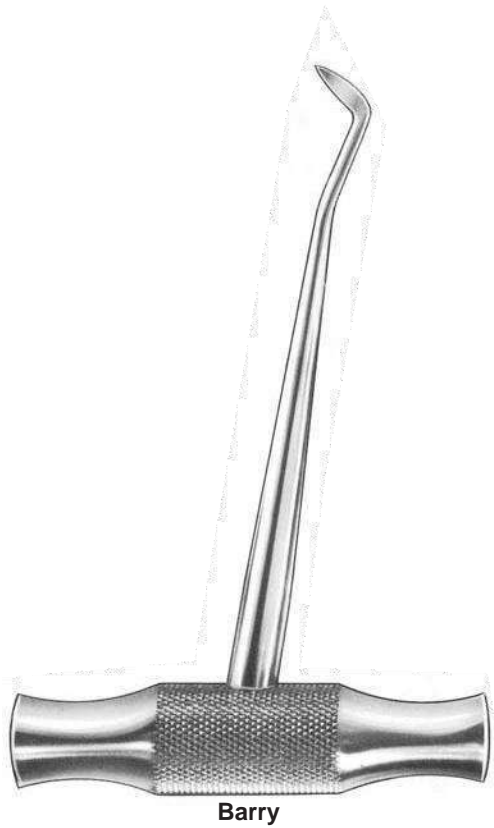

**Root Tip Elevators**  
 Décortiqueurs à fragments  
 Wurzelspitzenheber

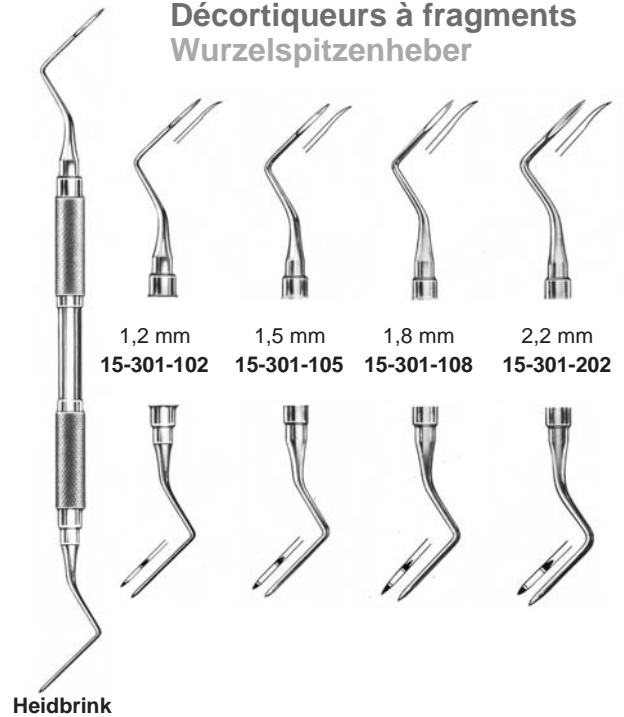

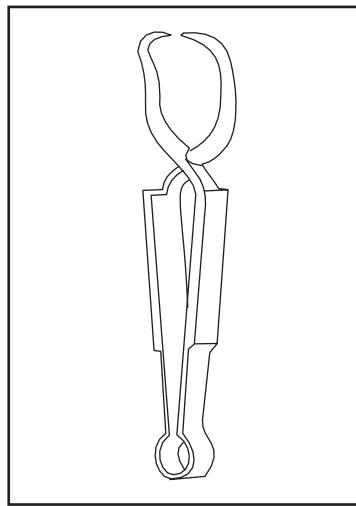

**Towel Clamps**  
**Pinces pour fixer les compresses**  
**Tuchklemmen**



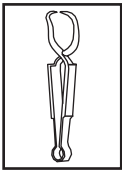

**Towel Clamps**  
**Pinces pour fixer les compresses**  
**Tuchklemmen**

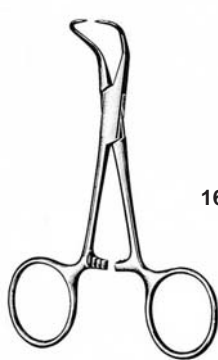

**Backhaus**

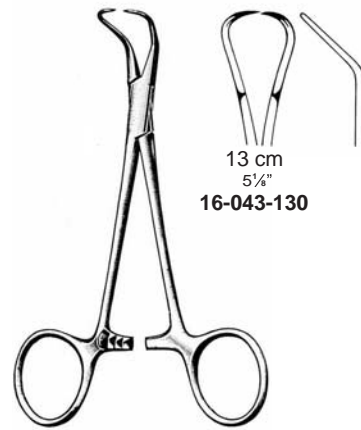
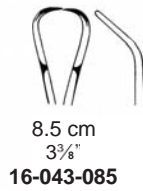

**Backhaus**

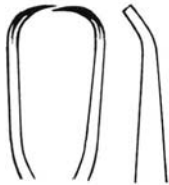
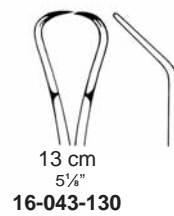

**Schaedel**  
8 cm  
3 1/8"

16-037-080

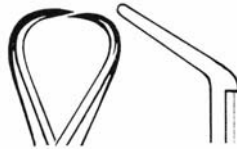

**Jones**  
8 cm  
3 1/8"

16-039-080

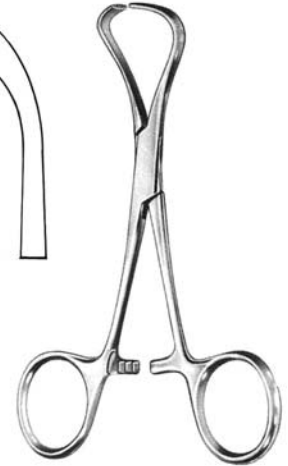

**Edna/Lorna**  
14 cm  
5 1/2"

16-047-140

**Splinter Forceps**  
**Pinces à échardes**  
**Splitterzangen**

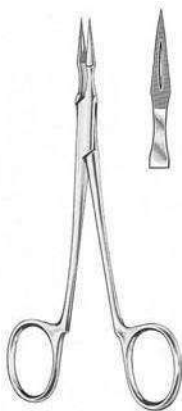

**Arthur**  
14 cm  
5 1/2"

16-078-140

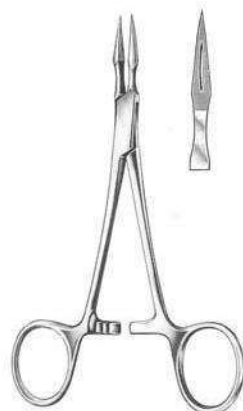

**Stieglitz (Willams)**  
14 cm  
5 1/2"

16-074-140



**Stieglitz (Willams)**  
14 cm  
5 1/2"

16-073-045

16-073-090



**Peet**  
11.5 cm  
4 1/2"

16-081-115



**Ralks (Virtus)**  
14 cm  
5 1/2"

16-072-140

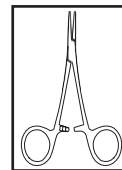

<b>Cohen</b> 10 cm 4"	<b>Cohen</b> 10 cm 4"	<b>Cohen # 1</b> 12 cm 4 3/4"	<b>Cohen # 2</b> 12 cm 4 3/4"	<b>Ilic</b> 13 cm 4 3/4"	<b>Sugarman</b> 16 cm 6 1/4"
<b>16-106-100</b>	<b>16-108-100</b>	<b>16-111-120</b>	<b>16-113-120</b>	<b>16-116-130</b>	<b>16-118-160</b>

**Dressing Forceps**  
**Pinces à pansements**  
**Kornzangen**

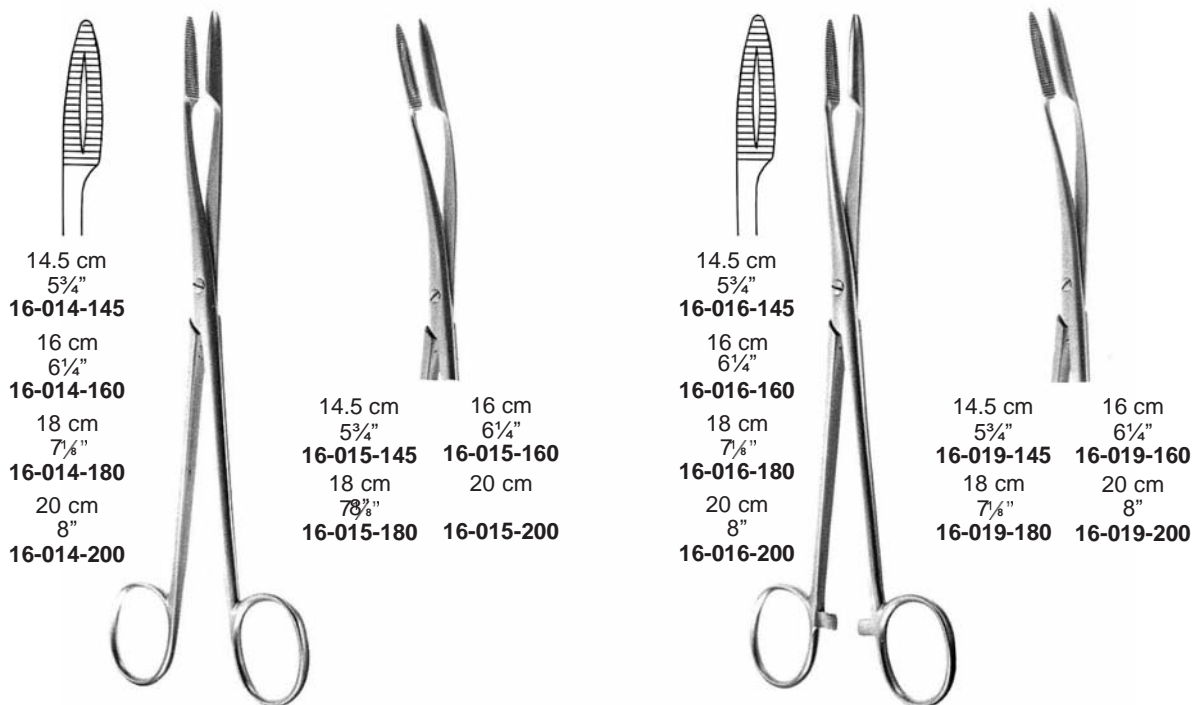

14.5 cm 5 3/4" <b>16-014-145</b>			14.5 cm 5 3/4" <b>16-016-145</b>		
16 cm 6 1/4" <b>16-014-160</b>			16 cm 6 1/4" <b>16-016-160</b>		
18 cm 7 1/8" <b>16-014-180</b>	14.5 cm 5 3/4" <b>16-015-145</b>	16 cm 6 1/4" <b>16-015-160</b>	18 cm 7 1/8" <b>16-016-180</b>	14.5 cm 5 3/4" <b>16-019-145</b>	16 cm 6 1/4" <b>16-019-160</b>
20 cm 8" <b>16-014-200</b>	18 cm 7 1/8" <b>16-015-180</b>	20 cm 8" <b>16-015-200</b>	20 cm 8" <b>16-016-200</b>	18 cm 7 1/8" <b>16-019-180</b>	20 cm 8" <b>16-019-200</b>



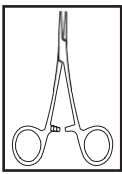

**Dressing Forceps**  
Pincès à pansements  
Kornzangen

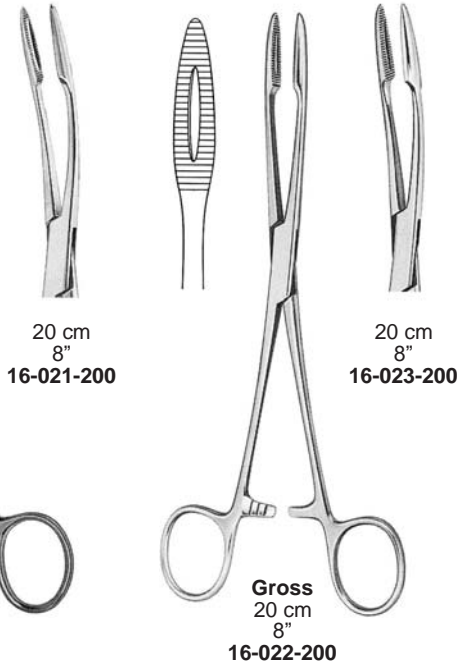
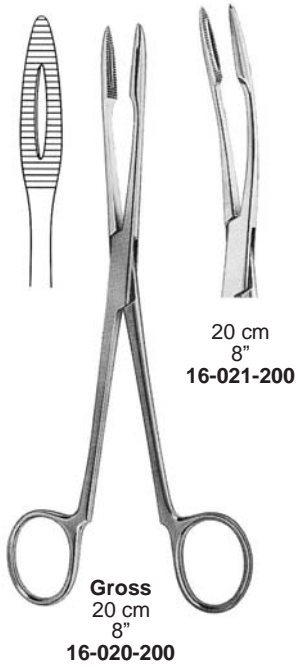

**Tongue Seizing Forceps**  
Pincès tire-langue  
Zungenzangen

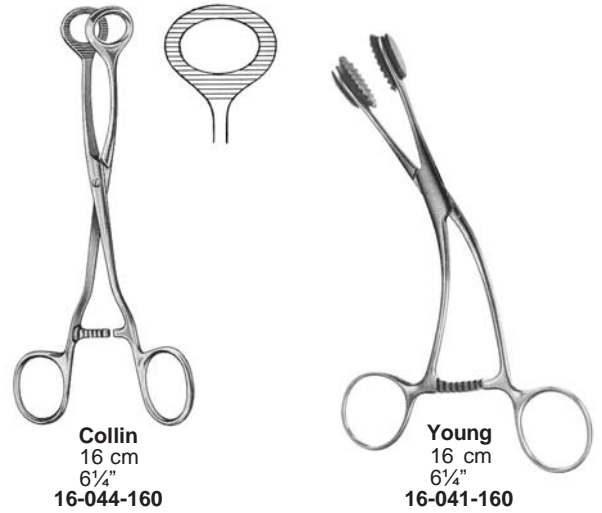

**Sterilizing Forceps**  
Pincès pour saisir les objets stérilisés  
Sterilisierzangen

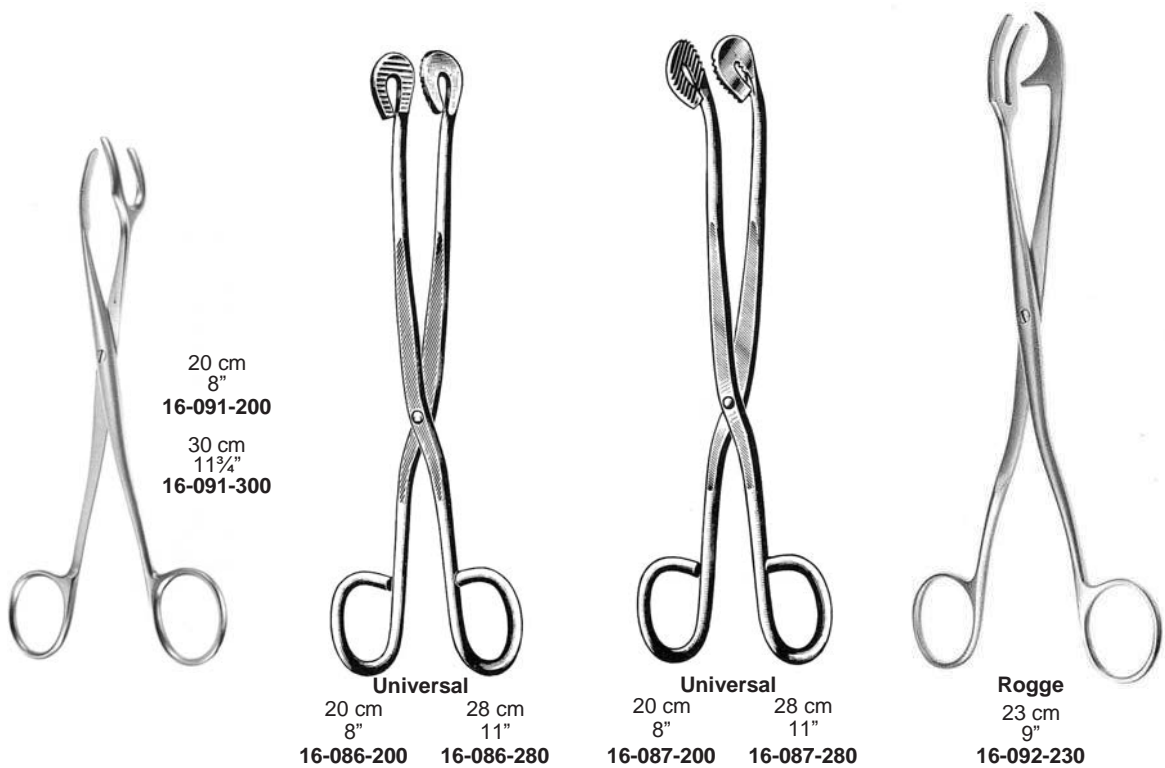

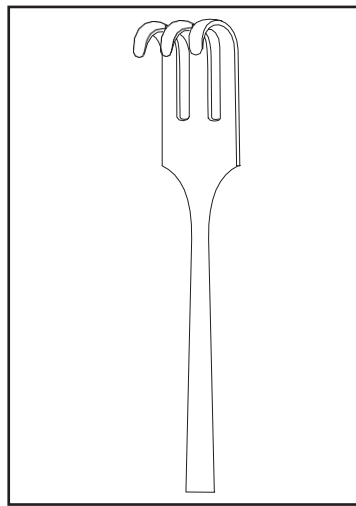

**Delicate Retractors**  
**Ecarteurs fins**  
**Feine Wundhaken**



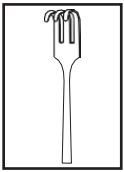

**Delicate Retractors**  
 Ecarteurs fins  
 Feine Wundhaken

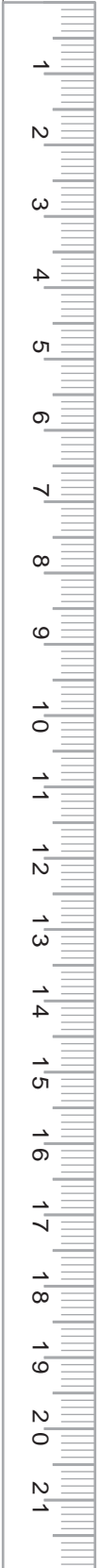

**Senn-Miller**  
 16 cm  
 6 1/4"  
 20-061-160



**Senn-Miller**  
 16 cm  
 6 1/4"  
 20-071-160

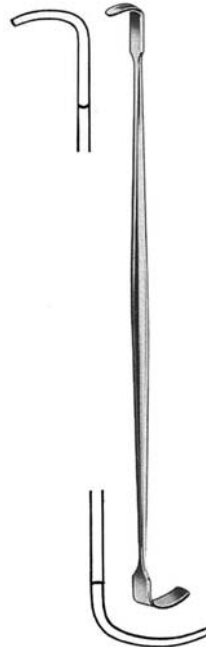

**Ragnell**  
 16 cm  
 6 1/4"  
 20-081-160

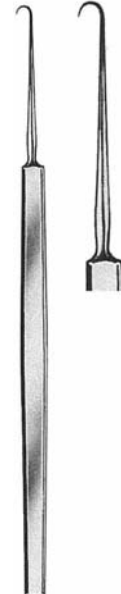

**Straight**  
 13 cm  
 5 1/8"  
 20-223-130



**Barsky**  
 15 cm  
 6"  
 20-136-150

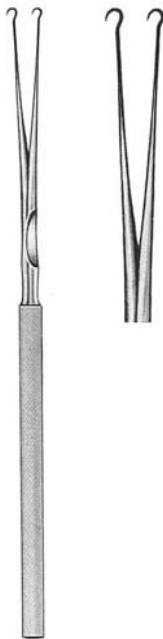

**Barsky**  
 15 cm  
 6"  
 20-137-150



**Gillies**  
 19 cm  
 7 1/2"

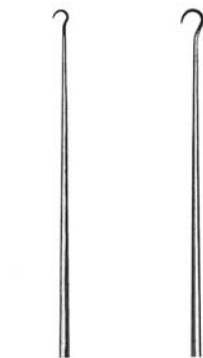

20-147-001 20-147-02

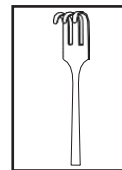

Sharp  
Pointu  
Spitz



20-049-001



20-049-002

Blunt  
mousse  
stumpf

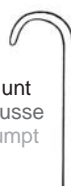

20-053-001



20-053-002



20-049-003



20-049-004



20-053-003



20-053-004



16 cm  
6 1/4"

Sharp  
Pointu  
Spitz



20-073-002



20-073-003

Blunt  
mousse  
stumpf



20-075-002



20-075-003



16 cm  
6 1/4"



16 cm  
6 1/4"  
20-050-160



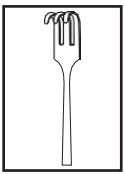

**Delicate Retractors**  
**Ecarteurs fins**  
**Feine Wundhaken**

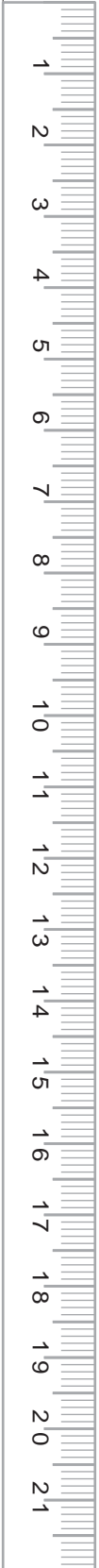

**Kirkland**



**No. 23K**  
**20-301-023**



**No. 24K**  
**20-301-024**



**No. 27K**  
**20-301-027**



**No. 28K**  
**20-301-028**

**Retractors**  
**Ecarteurs**  
**Wundhaken**



**Langenbeck**  
**21 cm**  
**8 1/4"**



**30 x 11 mm**  
**20-081-001**



**30 x 14 mm**  
**20-081-002**



**30 x 16 mm**  
**20-081-003**

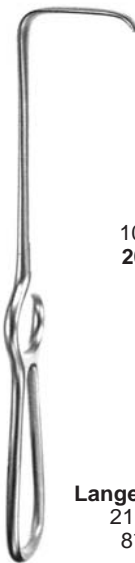

**Langenbeck**  
**21 cm**  
**8 1/4"**



**10 x 40 mm**  
**20-083-001**



**13 x 42 mm**  
**20-083-002**



**16 x 42 mm**  
**20-083-003**

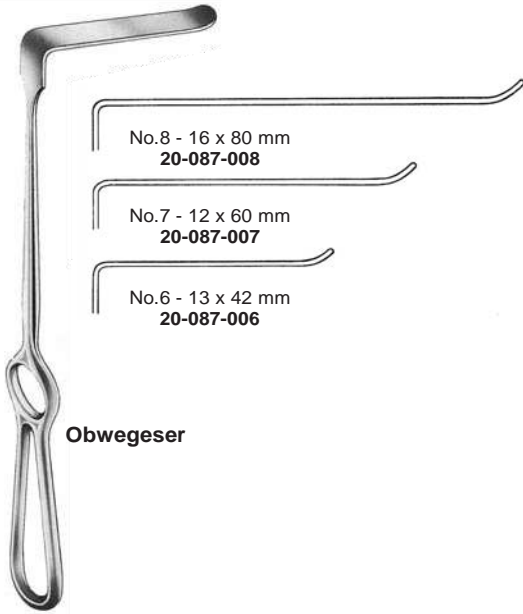
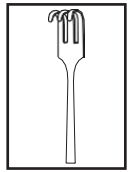

**Obwegeser**

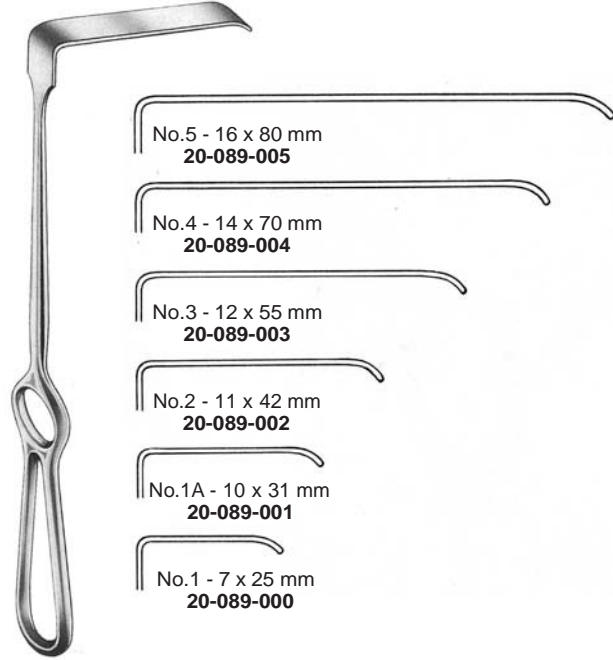

**Obwegeser**



**Middeldorpf**



**20-085-001**



**20-085-002**



**20-085-003**



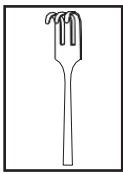

**Retractors**  
Ecarteurs  
Wundhaken



10 x 42 mm

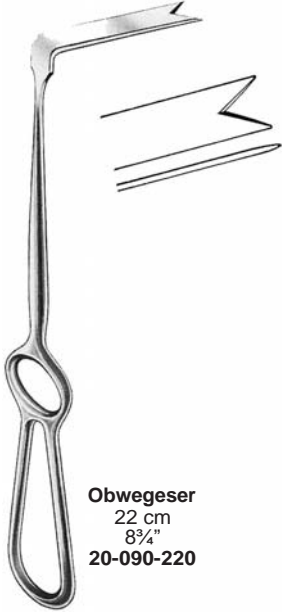

**Obwegeser**  
22 cm  
8¾"  
20-090-220

11 x 70 mm

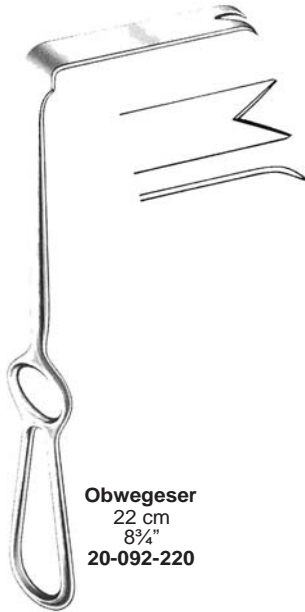

**Obwegeser**  
22 cm  
8¾"  
20-092-220

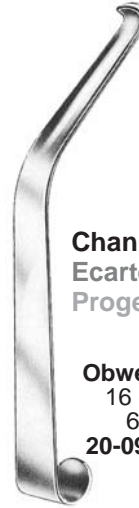

**Channel Retractor**  
Ecarteur Cannele  
Progenie-rinne

**Obwegeser**  
16 cm  
6¼"  
20-099-160

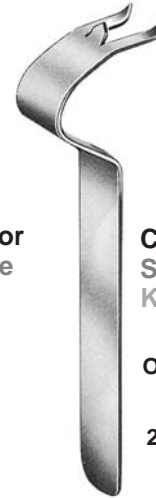

**Chin Retractor**  
Soutien-menton  
Kinnhalter

**Obwegeser**  
15.5 cm  
6⅛"  
20-100-160

**Awls**  
Alénes  
Ahlen



**Obwegeser**  
14 cm  
5½"  
20-115-140



**Obwegeser**  
23 cm  
9"  
20-117-230



**Obwegeser**  
18 cm  
7⅞"  
20-119-180



**Check Retractor**  
20-120-003



**Plaster Nipper**  
20-120-195



**Langenbeck**  
20-120-07 Small  
20-120-08 Medium  
20-120-09 Large



**Uni. of Mennisotta**  
20-120-001



**Simplex**  
20-120-002

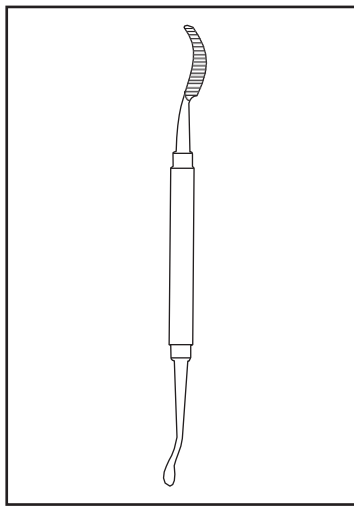

**Bone Files**  
**Limes à os**  
**Knochenfeilen**



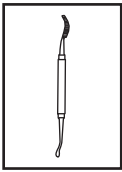

**Bone Elevators**  
Elevateurs  
Elevatoren

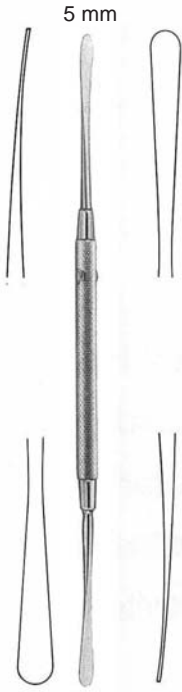
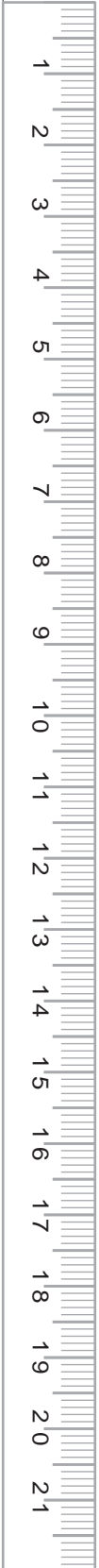

5 mm  
**Freer**  
19 cm  
1 1/2"  
24-291-190

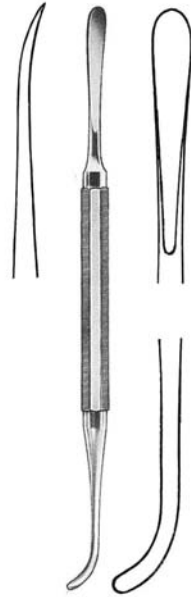

**Bennet**  
# 12S, 17 cm  
6 3/4"  
24-293-170

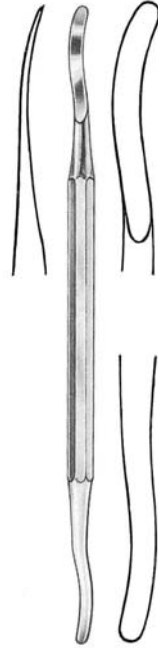

**Seldin**  
# 22, 19 cm  
1 1/2"  
24-295-190



**Seldin**  
# 23, 19.5 cm  
1 1/4"  
24-295-195



**Willigar**  
16 cm  
6 1/4"

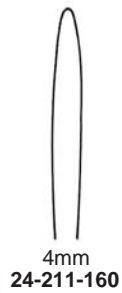

4mm  
24-211-160

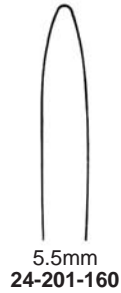

5.5mm  
24-201-160

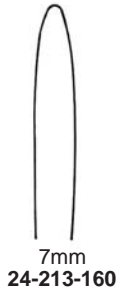

7mm  
24-213-160



**Henahan**  
17 cm  
6 3/4"



10 mm  
24-297-010



12 mm  
24-297-012



15 mm  
24-297-015

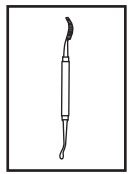

Sharp  
Tranchant  
Scharf

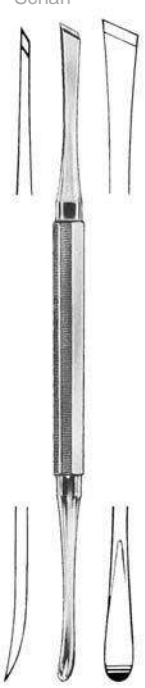

**Mead**  
16.5 cm  
6 1/2"  
24-221-165

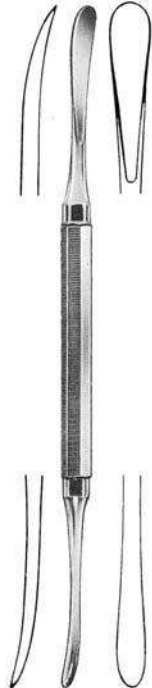

**Molt**  
18 cm  
7"  
24-213-180

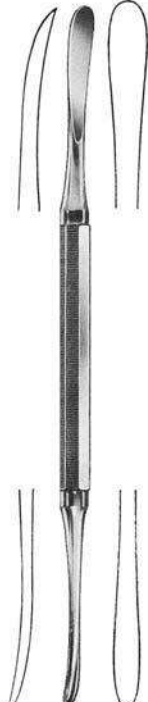

**Molt**  
18 cm  
7"  
24-215-180

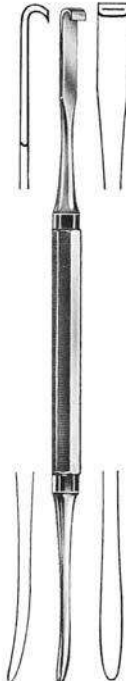

**Molt**  
18 cm  
7"  
24-217-180



**Molt**  
18 cm  
7"  
24-219-180



**Obwegeser-Freer**  
20.5 cm  
8"  
24-229-205

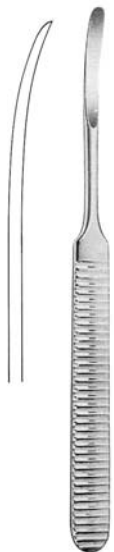

**Williger**  
16 cm  
6 1/4"

3 mm 24-361-003  
5 mm 24-361-005  
7 mm 24-361-007



**Kahre-Williger**  
16 cm  
6 1/4"

4 mm 24-365-004  
5 mm 24-365-005



**Obwegeser-Freer**  
21 cm  
8 1/4"  
24-227-210



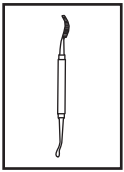

Raspatories  
Rugines  
Raspatorien



**Obwegeser**  
17.5 cm  
7"



**#1**  
6 mm  
24-243-001



**#2**  
7 mm  
24-243-002



**#3**  
9 mm  
24-243-003



**#4**  
11 mm  
24-243-004



**Obwegeser**  
20 cm  
8"



**#1**  
5 mm  
24-245-001

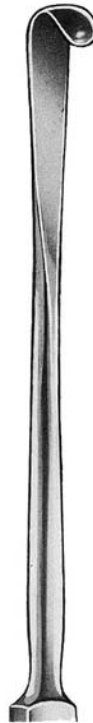

**#2**  
7 mm  
24-245-002



**#3**  
9 mm  
24-245-003

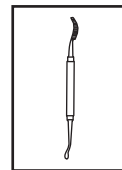

Miller  
# 10  
24-451-010

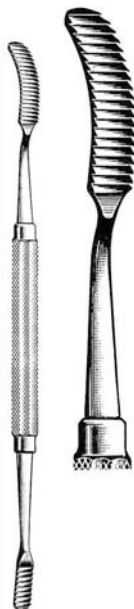

Miller  
# 11  
24-453-011

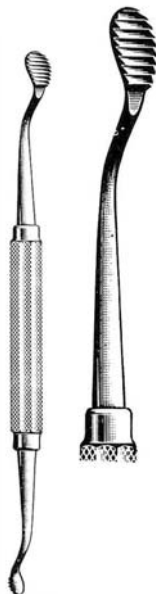

Miller  
# 12  
24-455-012

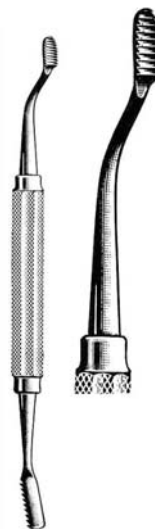

Miller  
# 13  
24-457-013

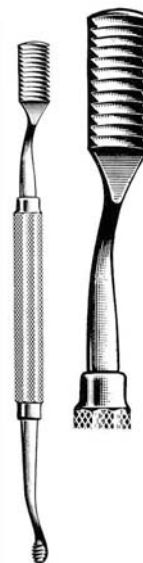

Miller  
# 14  
24-459-014

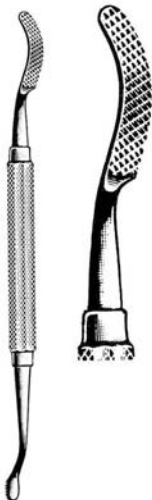

Miller  
# 10C  
24-461-010

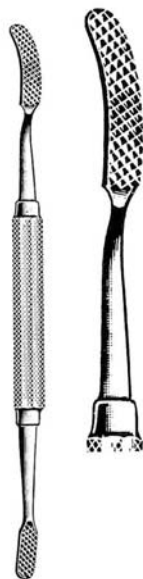

Miller  
# 11C  
24-471-011

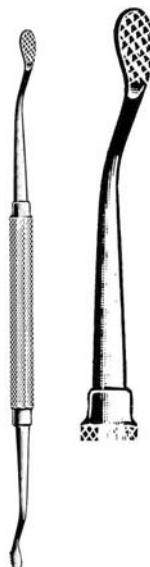

Miller  
# 12C  
24-473-012

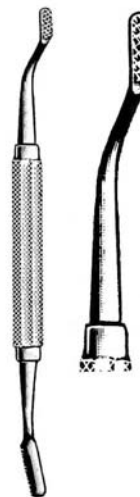

Miller  
# 13C  
24-475-013



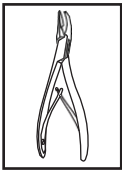

**Rongeurs**  
**Pinces Gouges**  
**Hohlmeißelzangen**

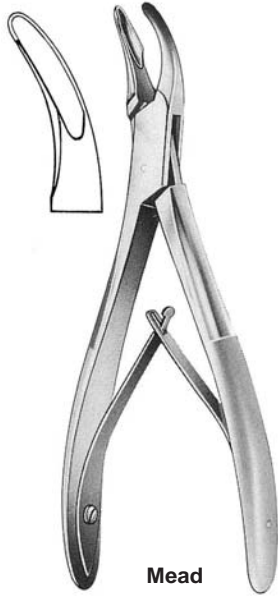
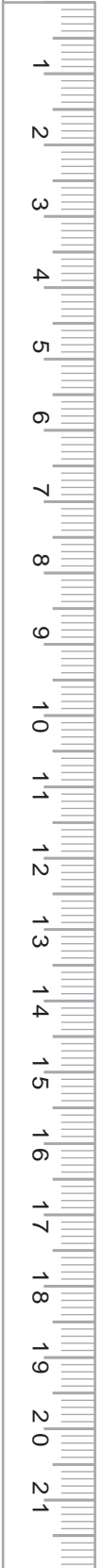

**Mead**  
 #4, 14 cm 5½"  
 28-209-140

#4A, 17 cm 6¾"  
 28-209-170

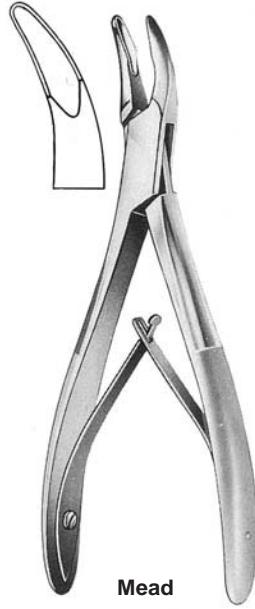

**Mead**  
 #1, 14 cm 5½"  
 28-211-140

#1A, 17 cm 6¾"  
 28-211-170



**Mead**  
 #2A, 17 cm 6¾"  
 28-213-170

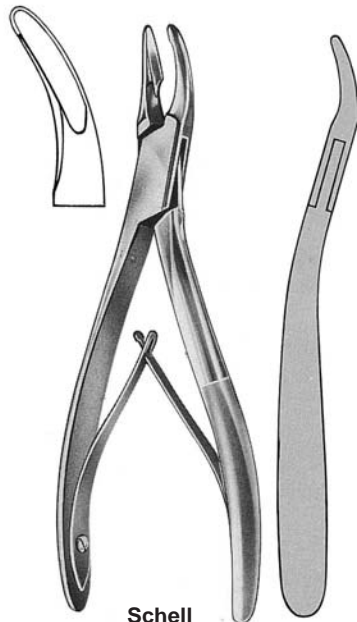

**Schell**  
 17 cm 6¾"  
 28-215-170

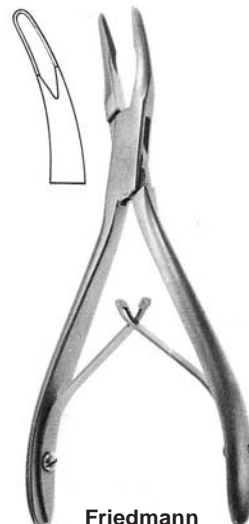

**Friedmann**  
 14 cm 5½"  
 28-231-140

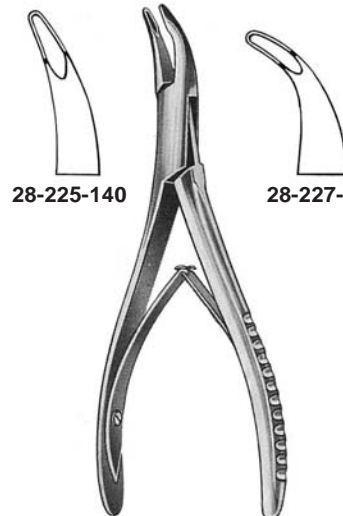

28-225-140

28-227-140

14 cm 5½"

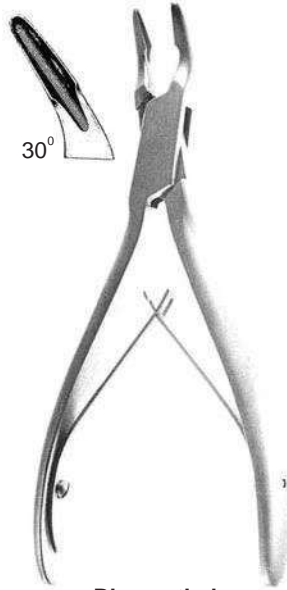
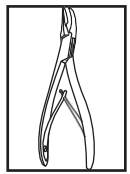

**Blumenthal**  
30°, 16 cm  
6 1/4"  
28-237-030

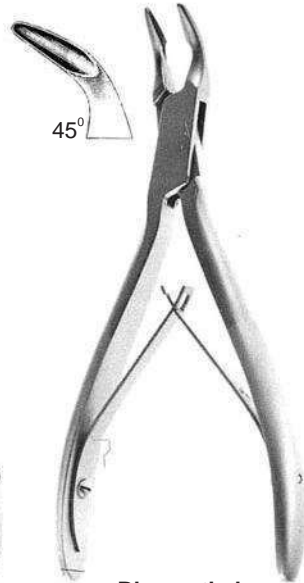

**Blumenthal**  
45°, 16 cm  
6 1/4"  
28-237-045

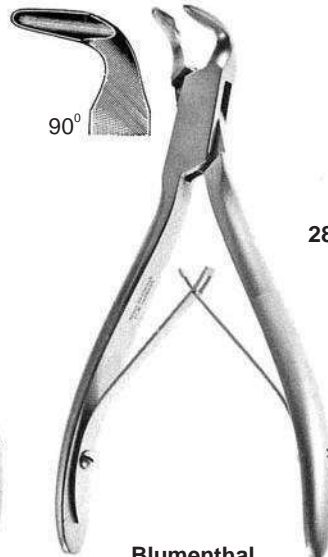

**Blumenthal**  
90°, 16 cm  
6 1/4"  
28-237-090

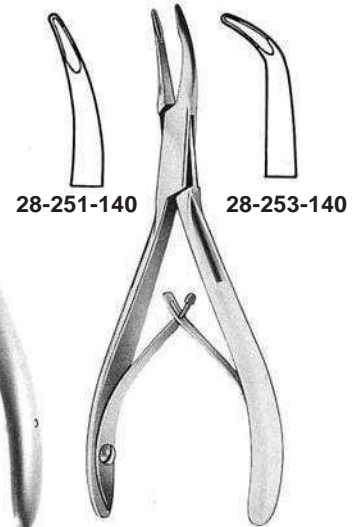

**Kleinert-Kutz**  
14 cm  
5 1/2"

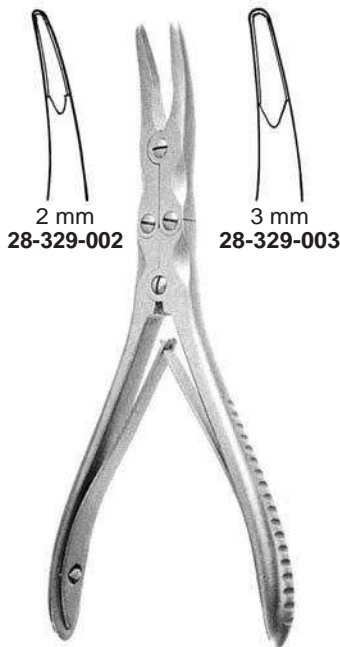

**Ruskin-Mini**  
15 cm  
6"



**Beyer**  
4 mm, 18 cm  
7 1/8"  
28-325-180



**Zaufal-Jansen**  
5 mm, 18 cm  
7 1/8"  
28-321-180



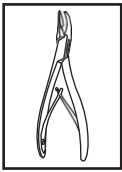

**Bone Cutting Forceps**  
**Pinces à os coupantes**  
**Knochensplitterzangen**

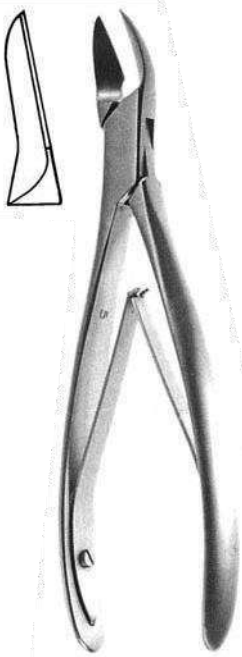
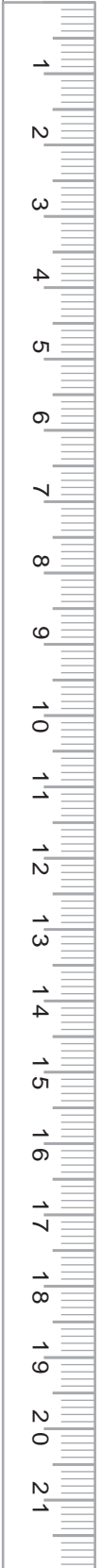

**Cleveland**  
 No. 5, 17 cm  
 6<sup>3</sup>/<sub>4</sub>"  
 28-625-170



**Niro**  
 No. 5S, 14 cm  
 5<sup>1</sup>/<sub>2</sub>"  
 28-437-140

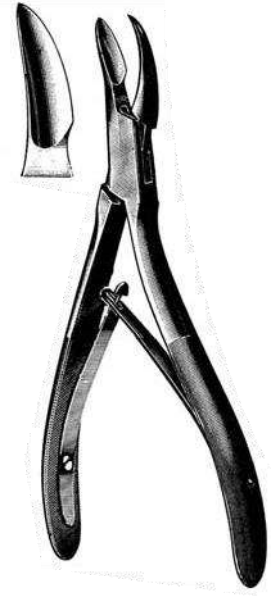

**Cleveland**  
 16 cm  
 6<sup>1</sup>/<sub>4</sub>"  
 28-629-160



**No. 18, 15 cm**  
 6"  
 28-631-150

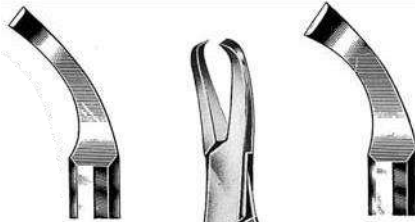

**No. 6A**  
 28-635-160

**No. 6**  
 28-637-160

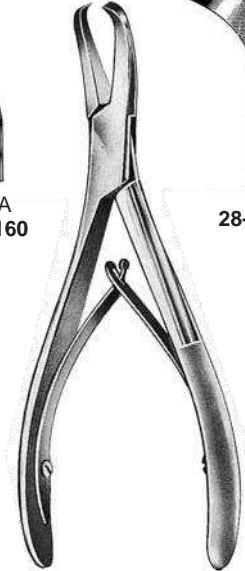

**Gardner**  
 16 cm  
 6<sup>1</sup>/<sub>4</sub>"



**Liston-mini**  
 15 cm  
 6"  
 28-618-150

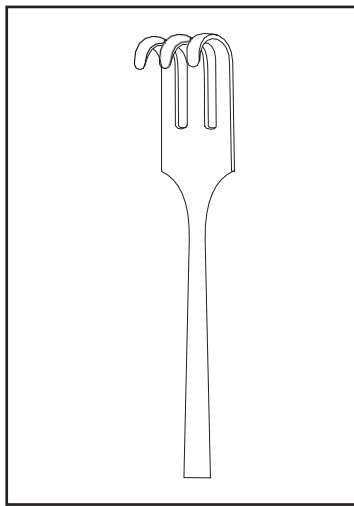

**Delicate Retractors**  
**Ecarteurs fins**  
**Feine Wundhaken**



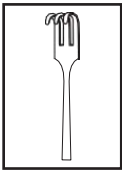

**Delicate Retractors**  
**Ecarteurs fins**  
**Feine Wundhaken**

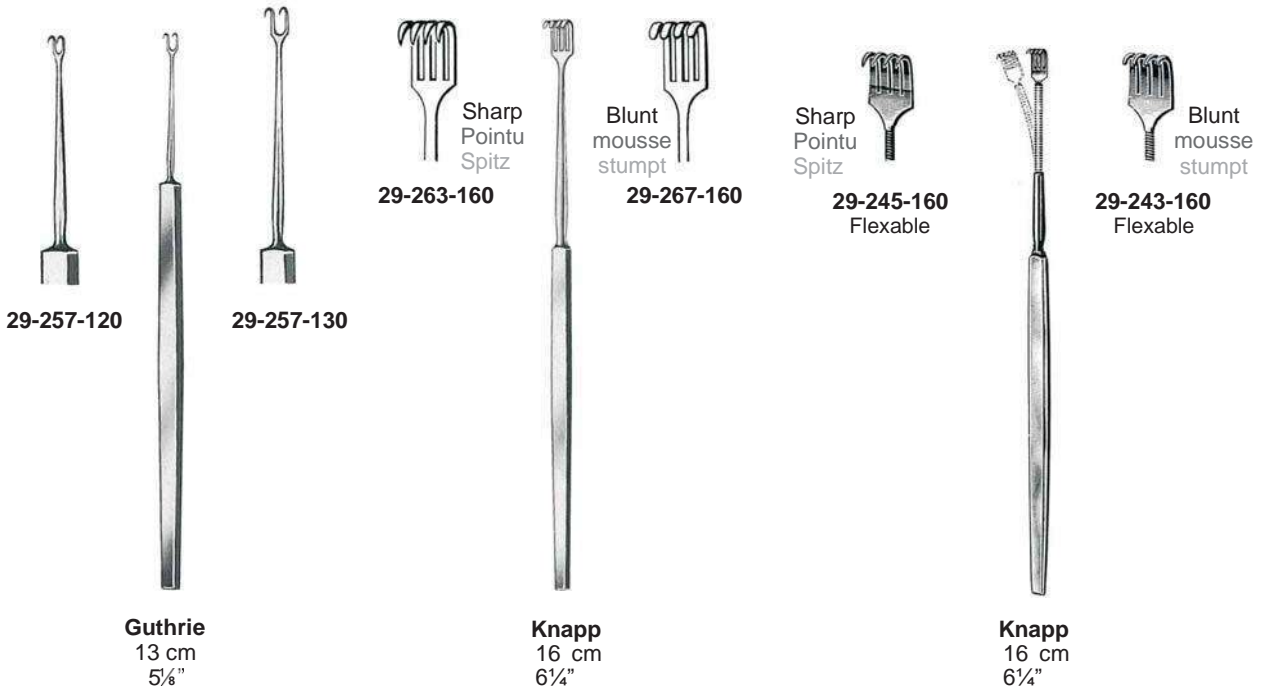

**Sharp Curettes**  
**Curettes tranchantes**  
**Scharfe Löffel**

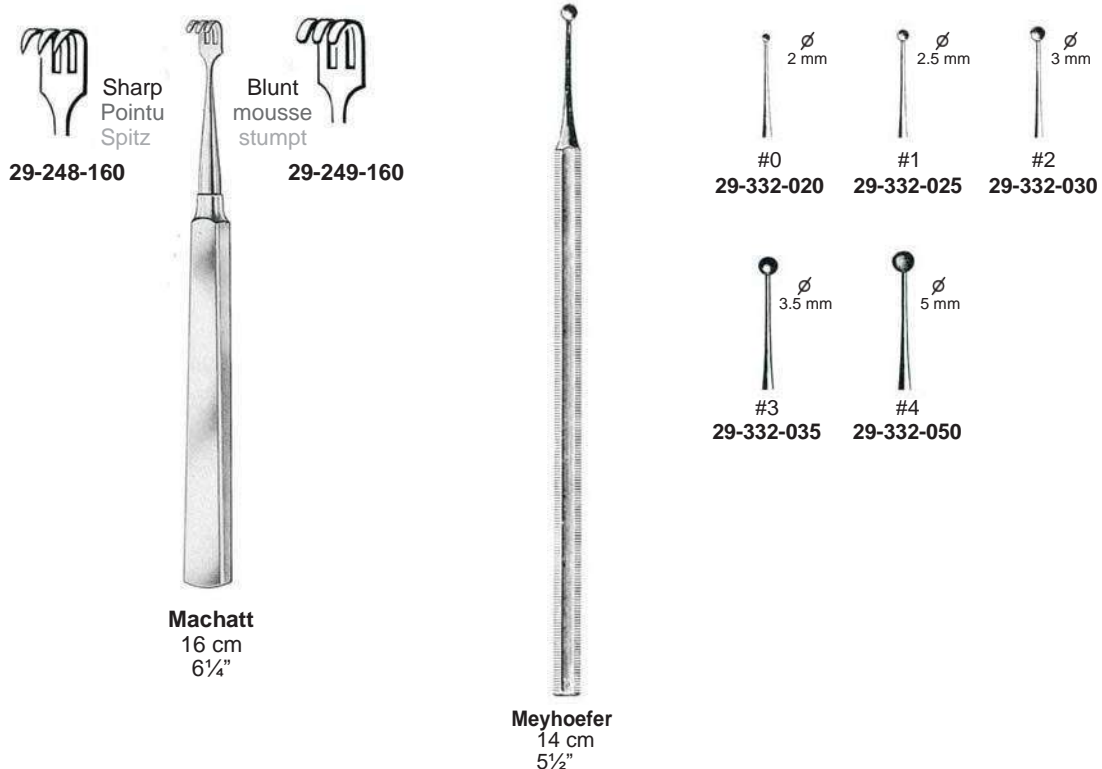

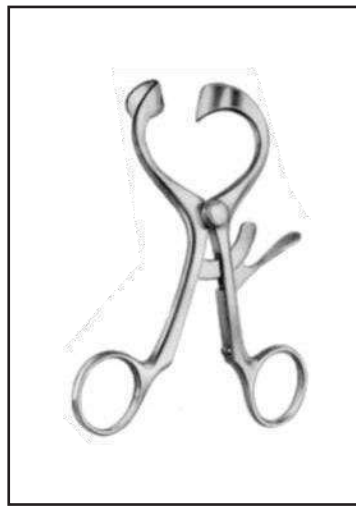

**Mouth Gags, Tongue Depressor**  
Ouvre-bouches, Abaisse-langues  
Mundsperrer, Zangenspatel



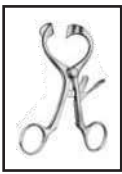

**Mouth Gags**  
Ouvre-bouches  
Mundsperrer



**Roser-König**

Cm.	Inch	
16	6 ¼	40-101-160
19	7 ½	40-101-190

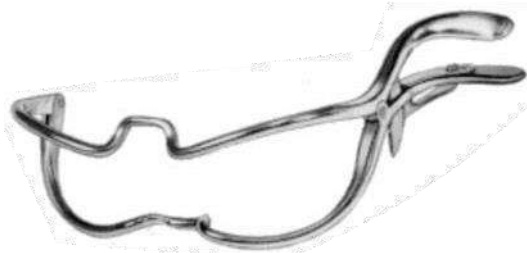

**Jennings**

Cm.	Inch	
9	3 ½	40-121-090
11	4 ½	40-121-110
13	5	40-121-130
15	6	40-121-150



**Heister**  
13 cm/ 5"  
40-130-130

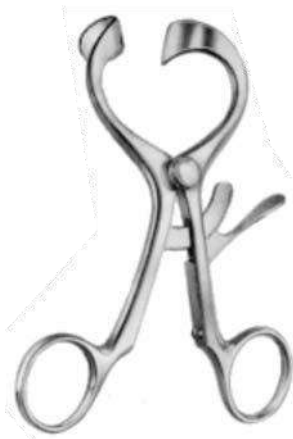

**Molt**  
11 cm/ 4 ½"  
40-135-110

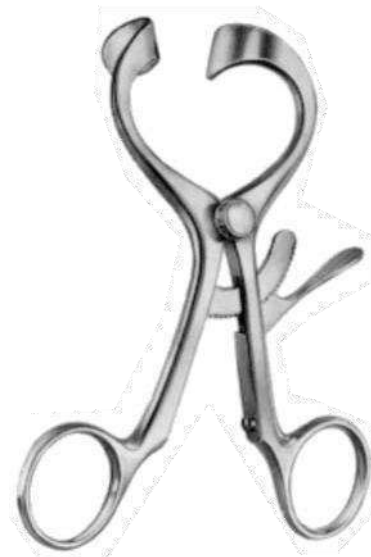

**Molt**  
14 cm/ 5 ½"  
40-135-140

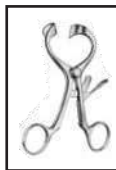

**Andrew**  
11 cm/ 22mm  
4 ½"  
40-179-110

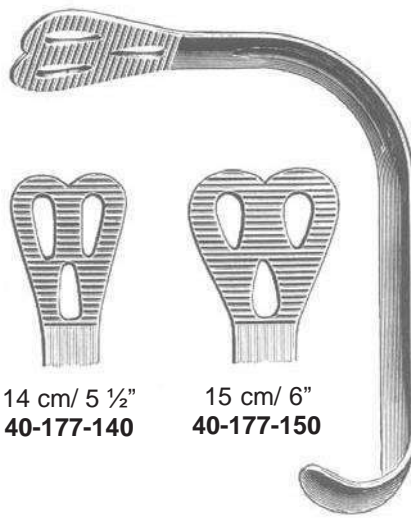

14 cm/ 5 ½"  
40-177-140

15 cm/ 6"  
40-177-150

**Wieder**  
11 cm/ 4 ½"  
40-177-110



**Doyen**  
22/29 mm  
13 cm/ 5"  
40-181-130



**Bruenings**  
19 cm/ 7 ½"  
40-175-190



**Buchwald**  
18/23mm  
18 cm/ 7"  
40-185-180



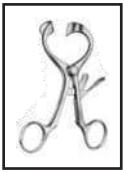

**Mouth Gags**  
Ouvre-bouches  
Mundsperrer

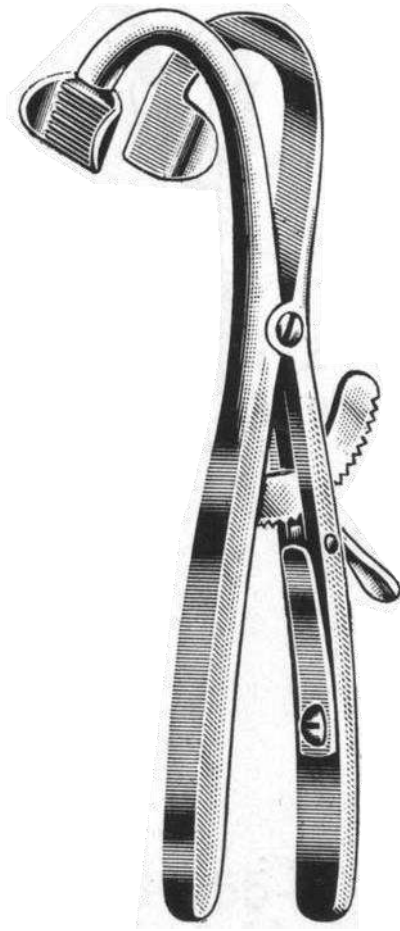

**Denhart**

Large  
40-135-001

Small  
40-135-002

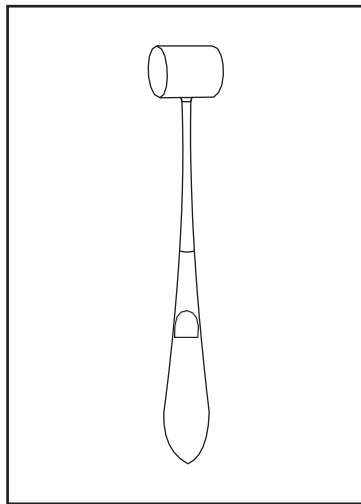

**Mallets**  
**Maillets**  
**Hämmer**

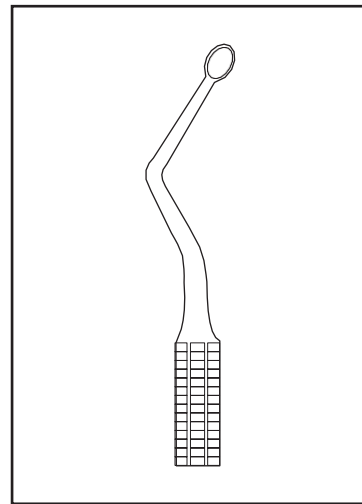

**Bone Curettes**  
**Curettes à os**  
**Knochenküretten**



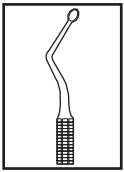

**Bone Curettes**  
Curettes à os  
Knochenküretten

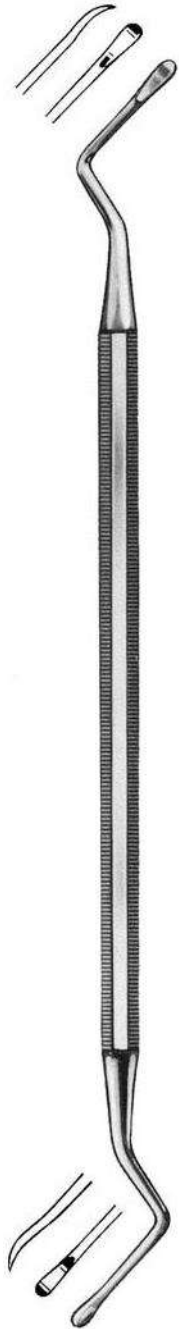

#1  
45-010-001

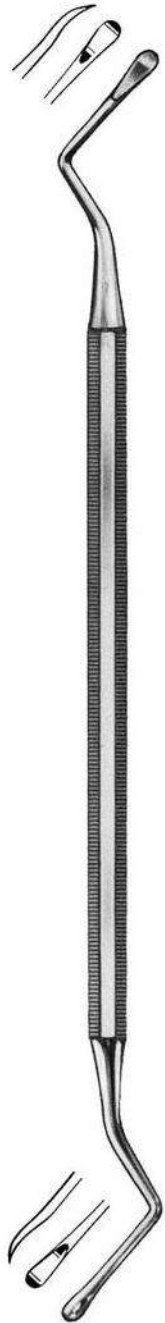

#2  
45-010-002

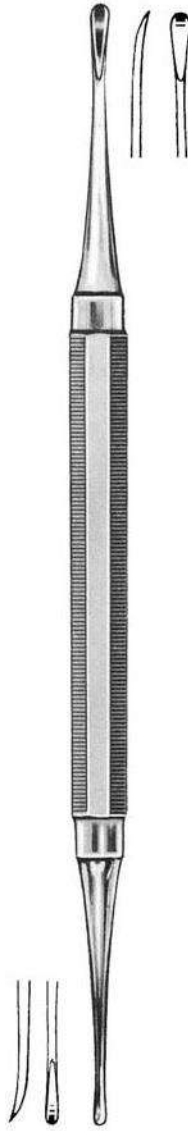

Miller  
2 + 3 mm  
45-012-001

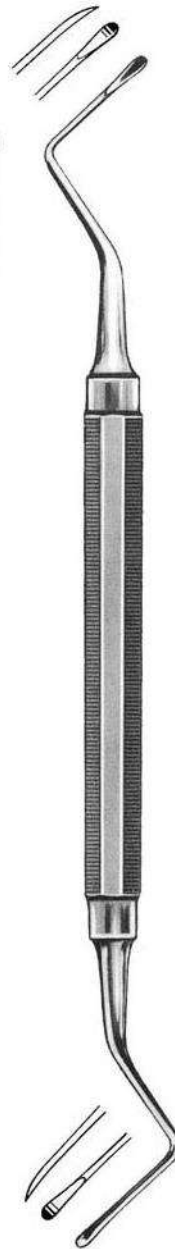

Miller  
2 mm  
45-012-002

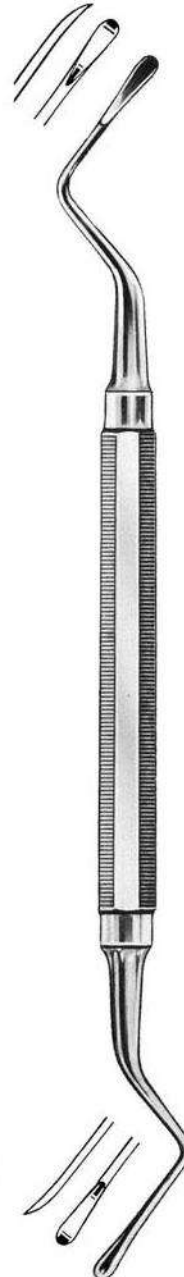

Miller  
3 mm  
45-012-003

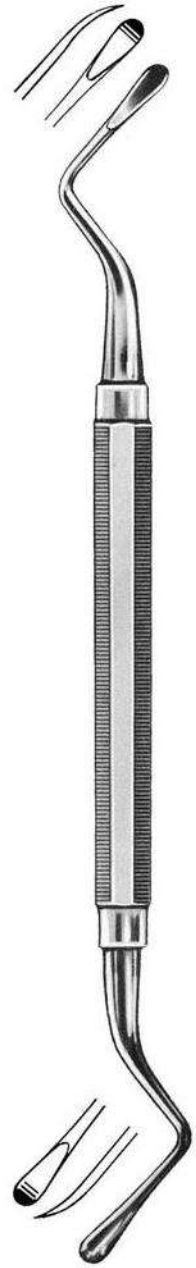

Miller  
4 mm  
45-012-004

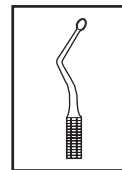

15 cm  
6"

45-022-001



15 cm  
6"

45-022-002



15 cm  
6"

45-022-003



**Hemingway**  
18 cm  
7 1/8"



#1



45-024-001



#2



45-024-002



#3



45-024-003



#4



45-024-004



**Volkman**  
17 cm  
6 3/4"



# 0000  
45-544-000



# 000  
45-544-001



# 00  
45-544-002



# 0  
45-544-003



# 1  
45-544-010



# 2  
45-544-020

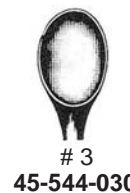

# 3  
45-544-030



# 4  
45-544-040

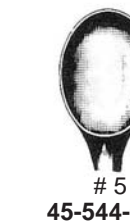

# 5  
45-544-050



# 6  
45-544-060



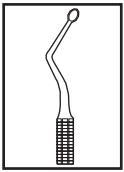

**Sharp Curettes**  
Curettes tranchantes  
Scharfe Löffel

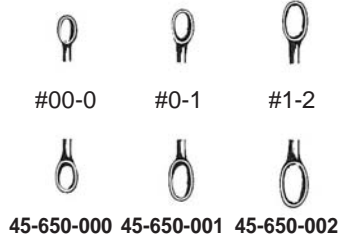

2 mm	45-653-002	45-655-002
3 mm	45-653-003	45-655-003

**Mallets**  
Maillets  
Hämmer

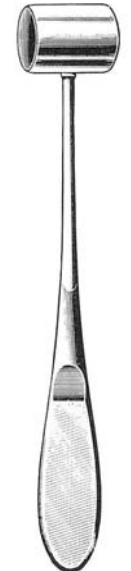

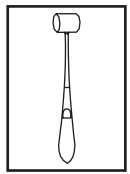

Partsch

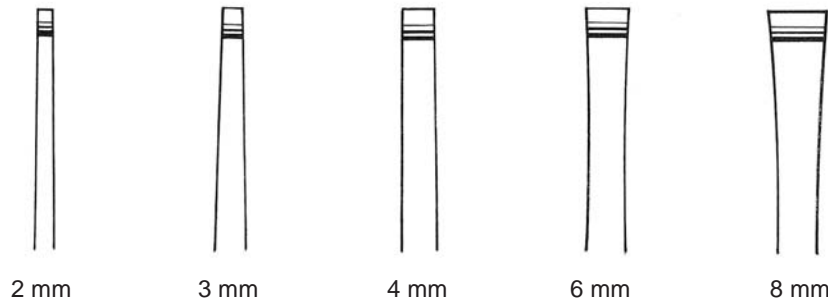

Cm		2 mm	3 mm	4 mm	6 mm	8 mm
14 5½"	<b>45-410-002</b>	<b>45-410-003</b>	<b>45-410-004</b>	<b>45-410-006</b>	<b>45-410-008</b>	
17 6¾"	<b>45-414-002</b>	<b>45-414-003</b>	<b>45-414-004</b>	<b>45-414-006</b>	<b>45-414-008</b>	

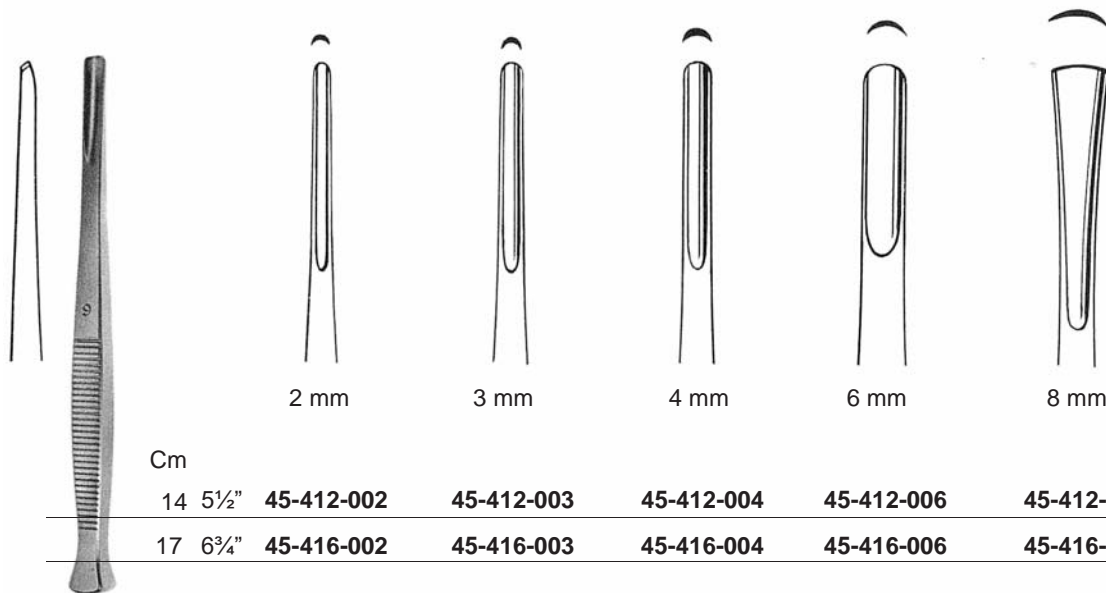

Partsch

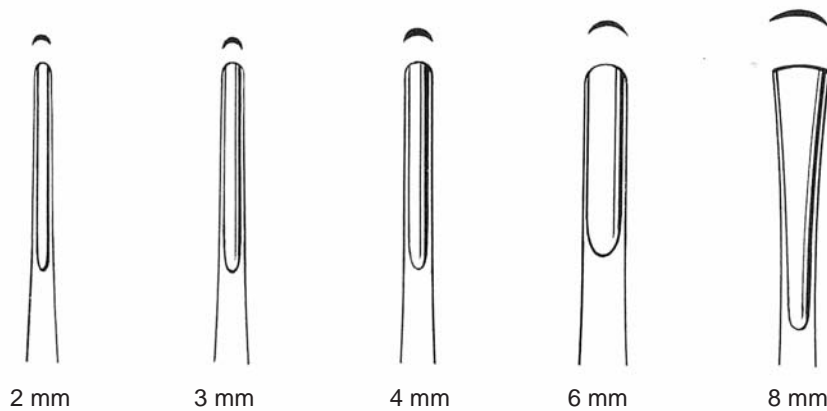

Cm		2 mm	3 mm	4 mm	6 mm	8 mm
14 5½"	<b>45-412-002</b>	<b>45-412-003</b>	<b>45-412-004</b>	<b>45-412-006</b>	<b>45-412-008</b>	
17 6¾"	<b>45-416-002</b>	<b>45-416-003</b>	<b>45-416-004</b>	<b>45-416-006</b>	<b>45-416-008</b>	



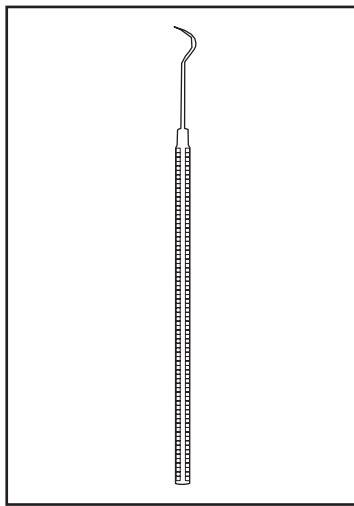

**Dental Probes**  
**Sondes dentaires**  
**Zahnsonden**





Dental Probes  
Sondes dentaires  
Zahnsonden

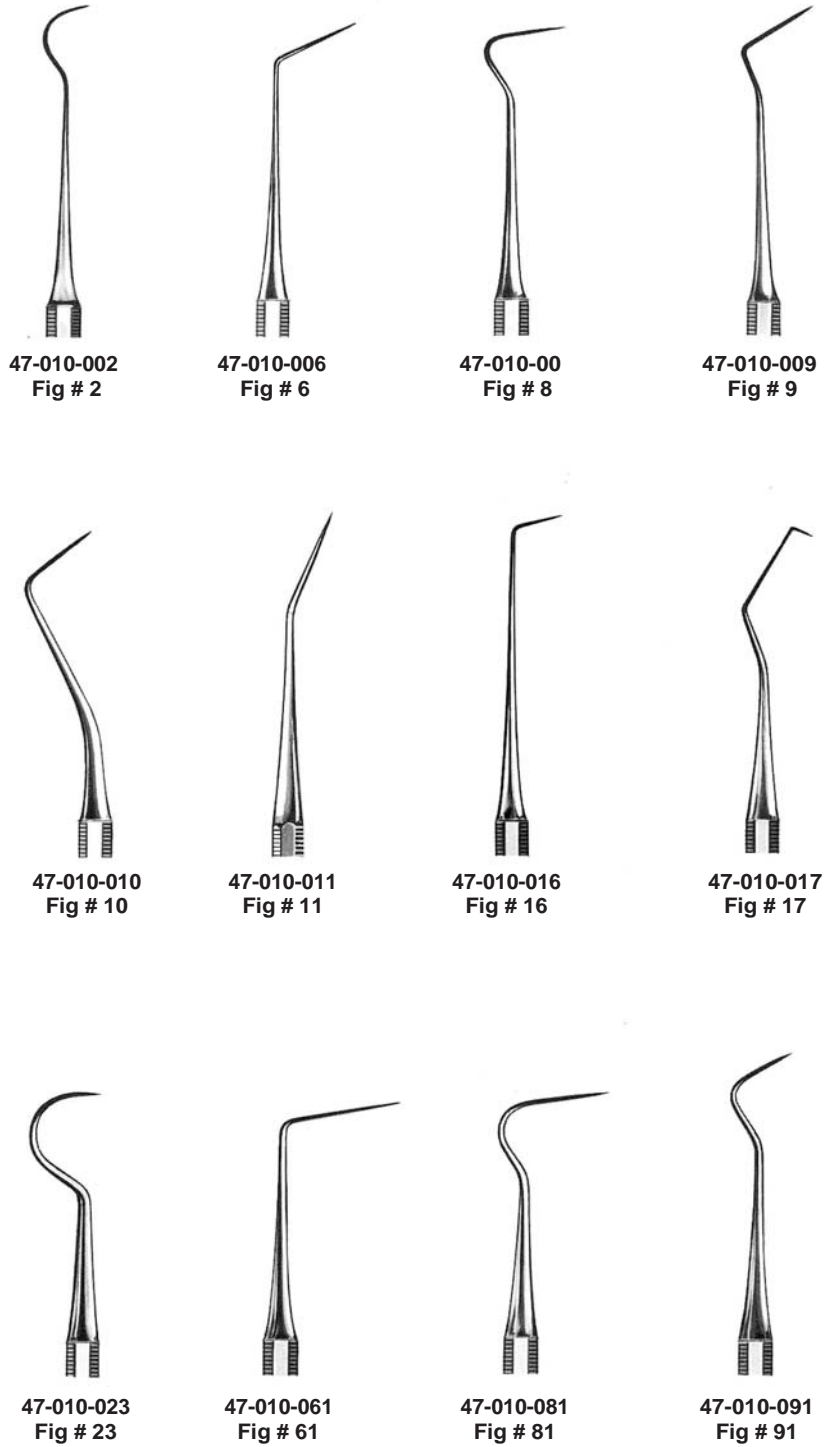
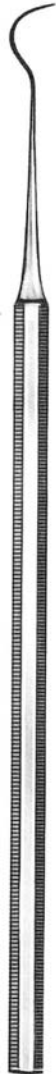

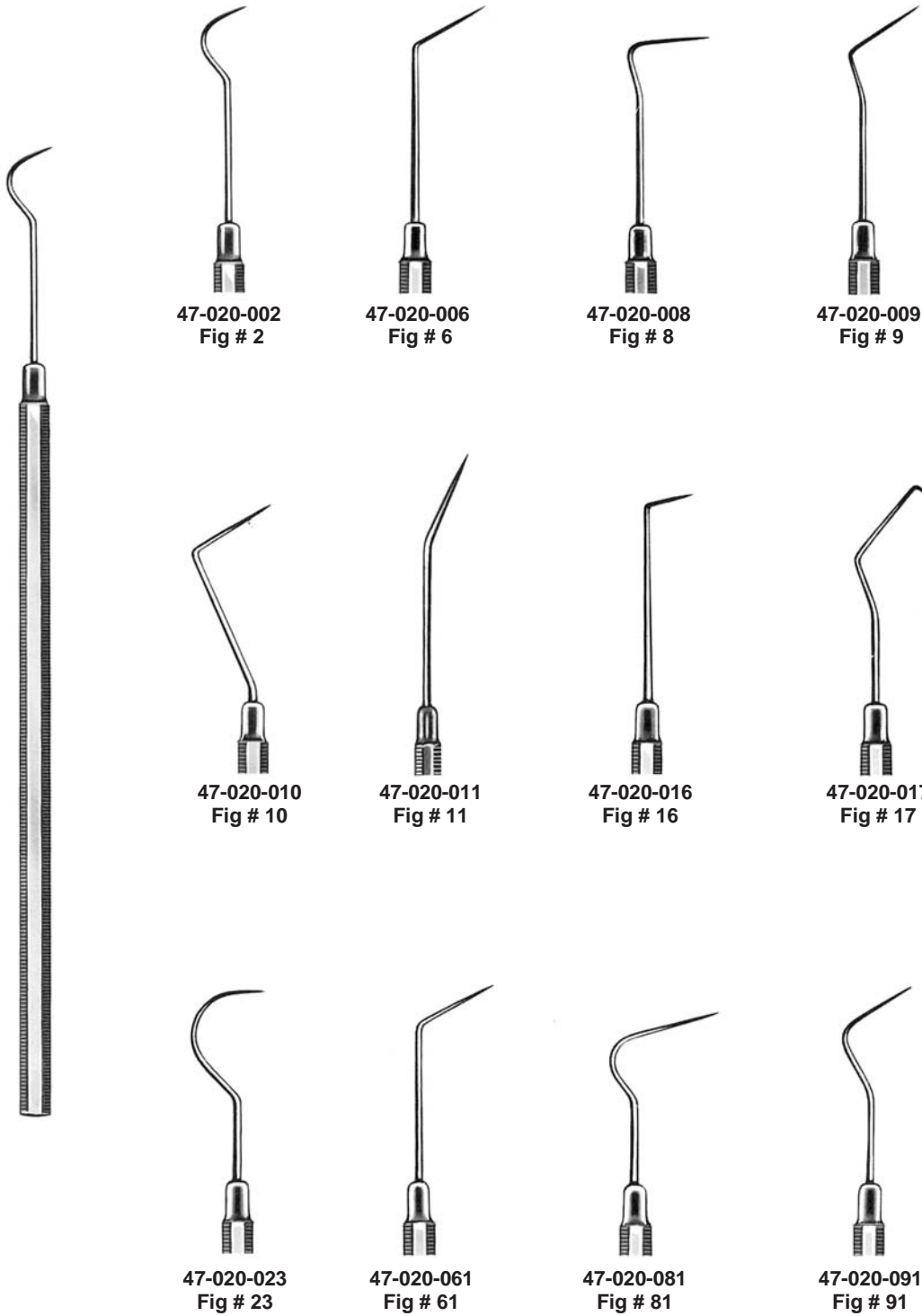
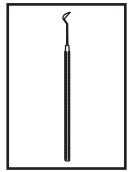

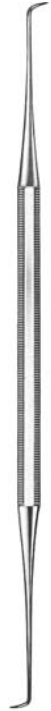

Fig 1  
 47-030-001



Fig 2  
 47-030-002



Fig 3  
 47-030-003



Fig 4  
 47-030-004



Fig 5  
 47-030-005



Fig 6  
 47-030-006

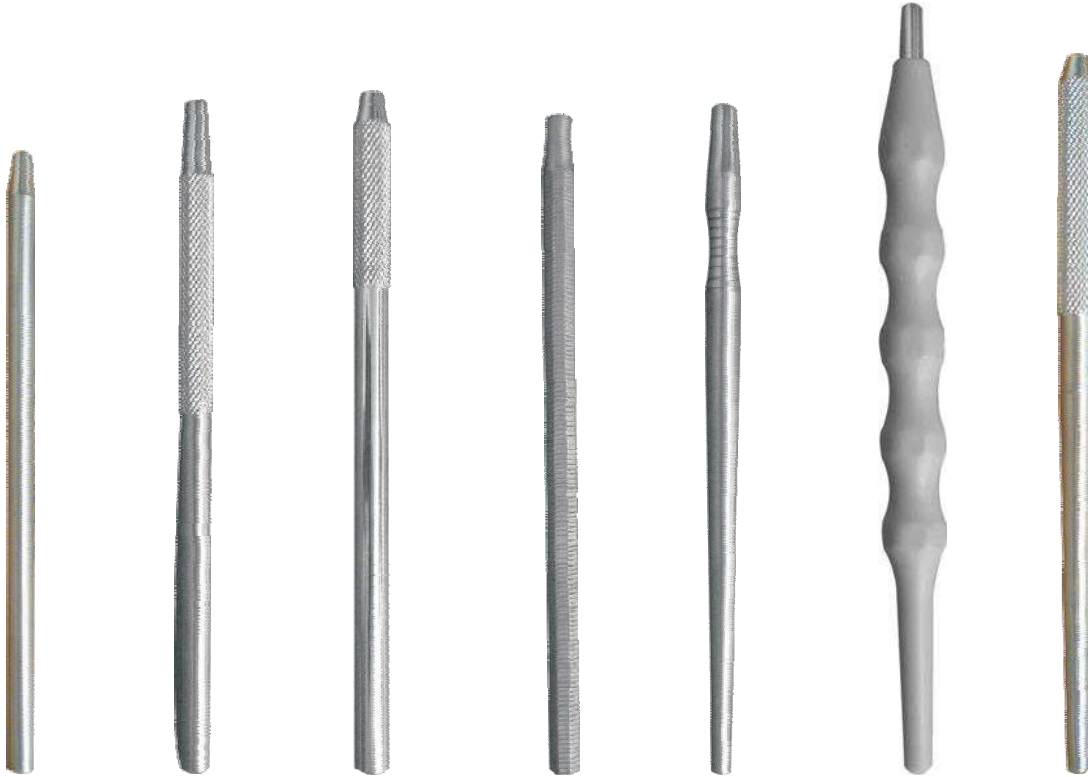
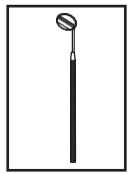

Fig 8  
 47-030-008

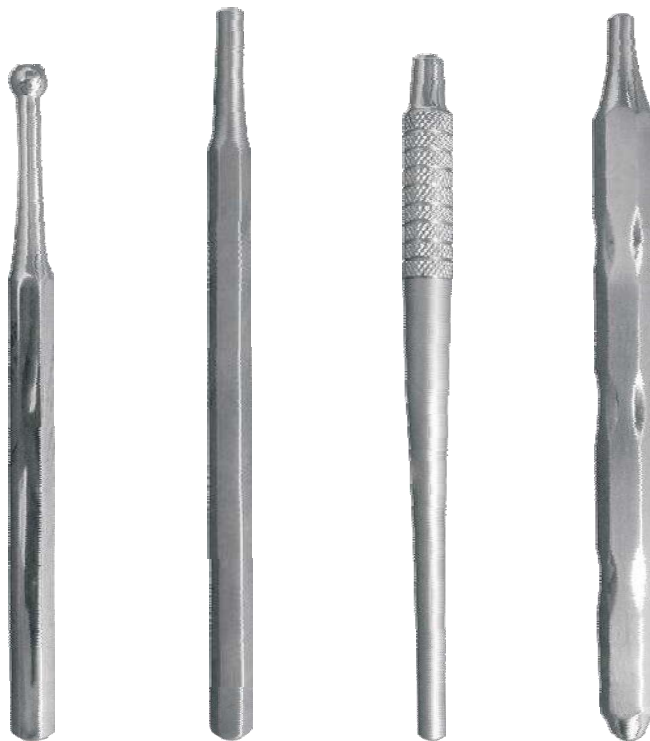

Fig 10  
 47-030-010





47-050-001    47-050-002    47-050-003    47-050-004    47-050-005    47-050-006    47-050-007



47-051-001    47-051-002    47-051-003    47-051-004





**Mouth Mirrors**  
 Mirooms à bouche  
 Mundspiegel

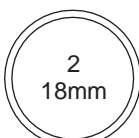
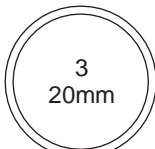
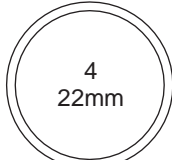
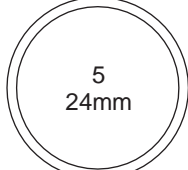

Plain Non-grossissant Plan	Sizes Grandeurs Größen	Magnifying Grossissant Vergrößernd	Front Surface
47-060-016	 1 16mm	47-062-016	47-065-016
47-060-018	 2 18mm	47-062-018	47-065-018
47-060-020	 3 20mm	47-062-020	47-065-020
47-060-022	 4 22mm	47-062-022	47-065-022
47-060-024	 5 24mm	47-062-024	47-065-024

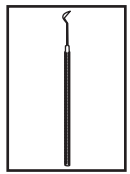

47-031-001



47-032-001



47-033-001



47-034-001



47-035-001



47-036-001



47-037-001



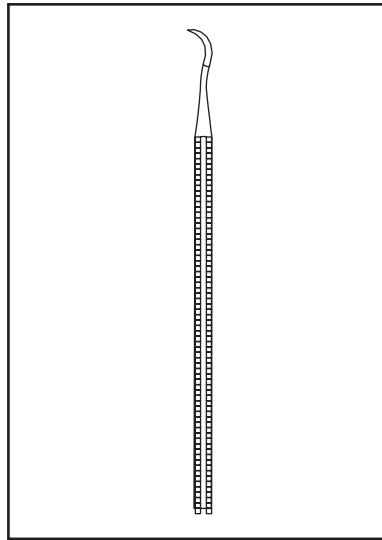

**Dental Scalers**  
Instruments à détartrer  
Zahnreiniger



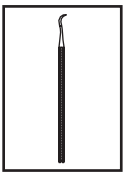

**Dental Scalers**  
 Instruments à détartrer  
 Zahnreiniger



**Darby-Perry**

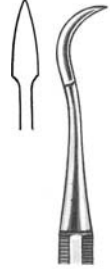

# 1  
49-010-001



# 2  
49-010-002



# 3  
49-010-003



# 6  
49-010-006



# 7  
49-010-007



# 14  
49-010-014



# 32  
49-010-032



# 33  
49-010-033



# 34  
49-010-034



# 33½  
49-010-335



# 34½  
49-010-345



# 1  
49-011-001



# 2  
49-011-002



# 5  
49-011-005



# 6  
49-011-006



# 11  
49-011-011

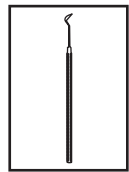
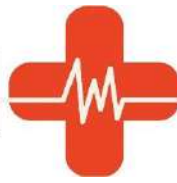

**Black**



**Zerfing  
49-026-000**



**Hygienist**



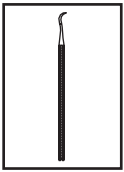

**Dental Scalers**  
 Instruments à détartrer  
 Zahnreiniger



**McCall**

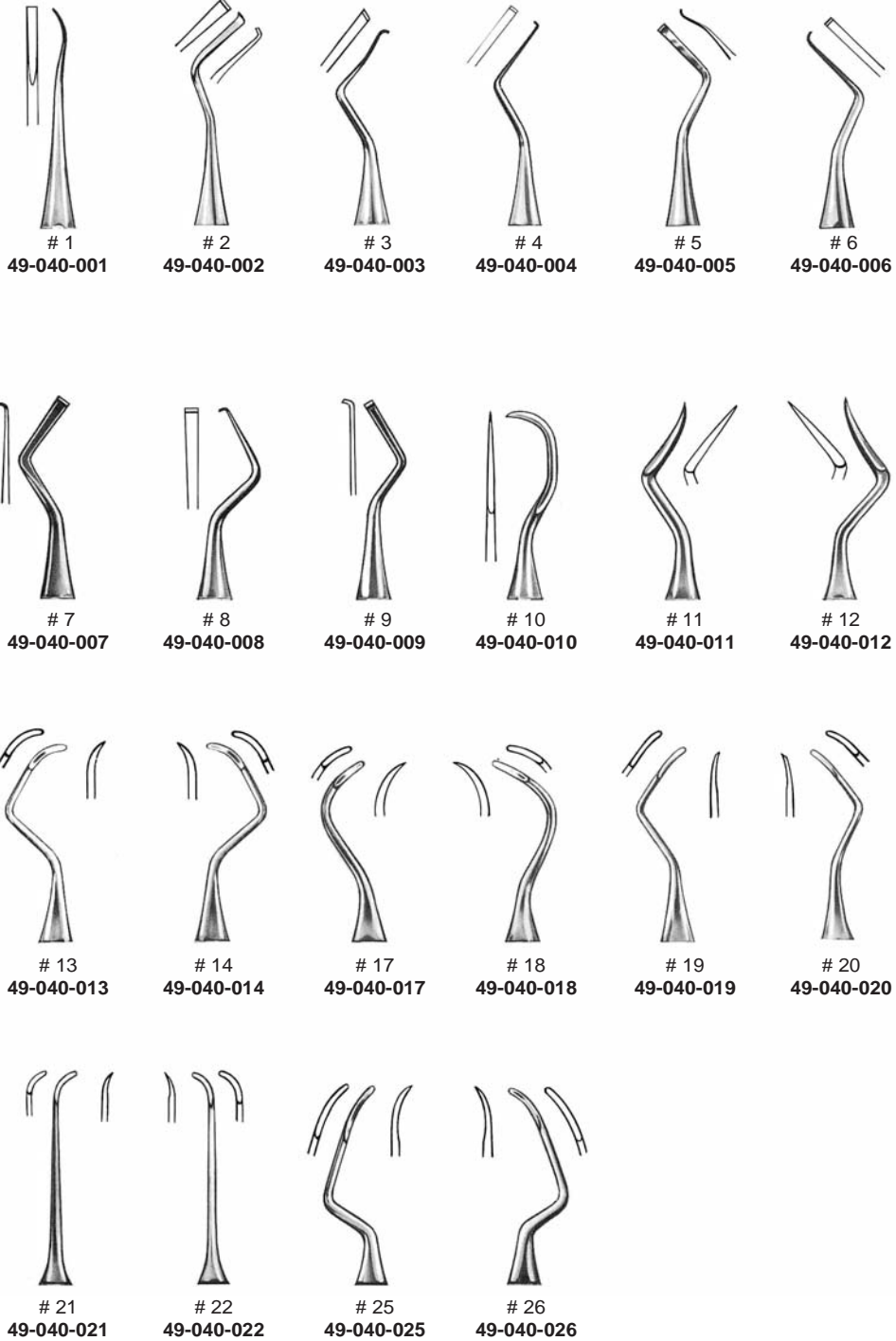

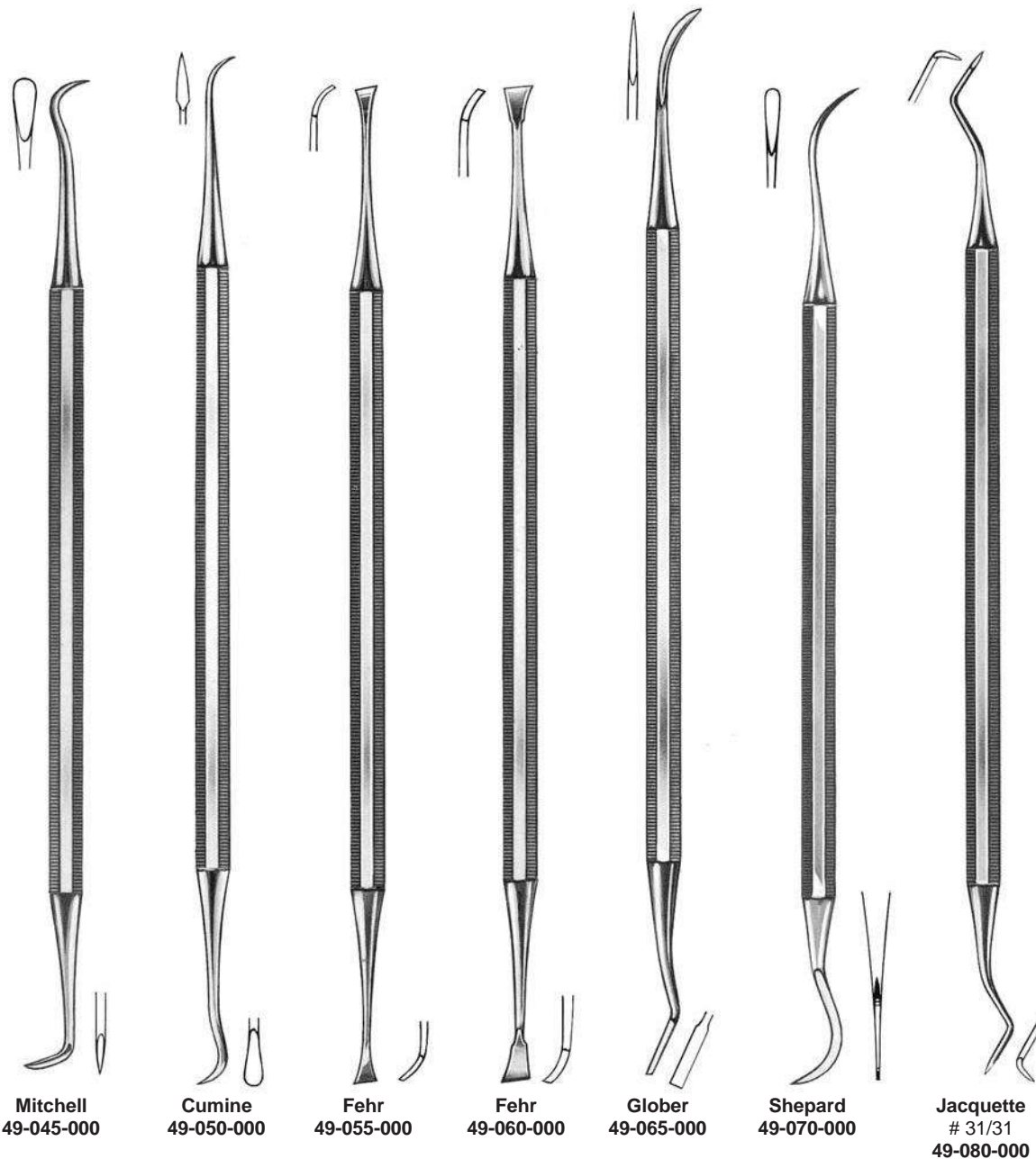
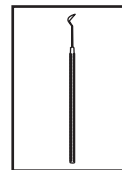

**Mitchell**  
49-045-000

**Cumine**  
49-050-000

**Fehr**  
49-055-000

**Fehr**  
49-060-000

**Glober**  
49-065-000

**Shepard**  
49-070-000

**Jacquette**  
# 31/31  
49-080-000

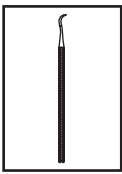

**Gracey**



No P1  
49-090-001



P2  
49-090-002



P3  
49-090-003



P4  
49-090-004



P5  
49-090-005



P6  
49-090-006



P7  
49-090-007



P8  
49-090-008



**McCall**



No 65  
49-100-065



No 66  
49-100-066



No 67  
49-100-067



No 68  
49-100-068



No 87  
49-100-087



No 88  
49-100-088

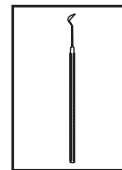

No.2  
Rothner  
49-110-002



No.3  
Rothner  
49-110-003



No.U15  
Towner  
49-110-015



No.69  
Towner  
49-110-069



No.TK  
49-110-070



Zerfing  
49-110-100



49-110-080



49-110-090



49-120-001



49-120-002



49-120-003



49-120-004



49-120-005



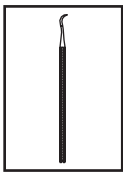

**Dental Scalers**  
 Instruments à détartrer  
 Zahnreiniger

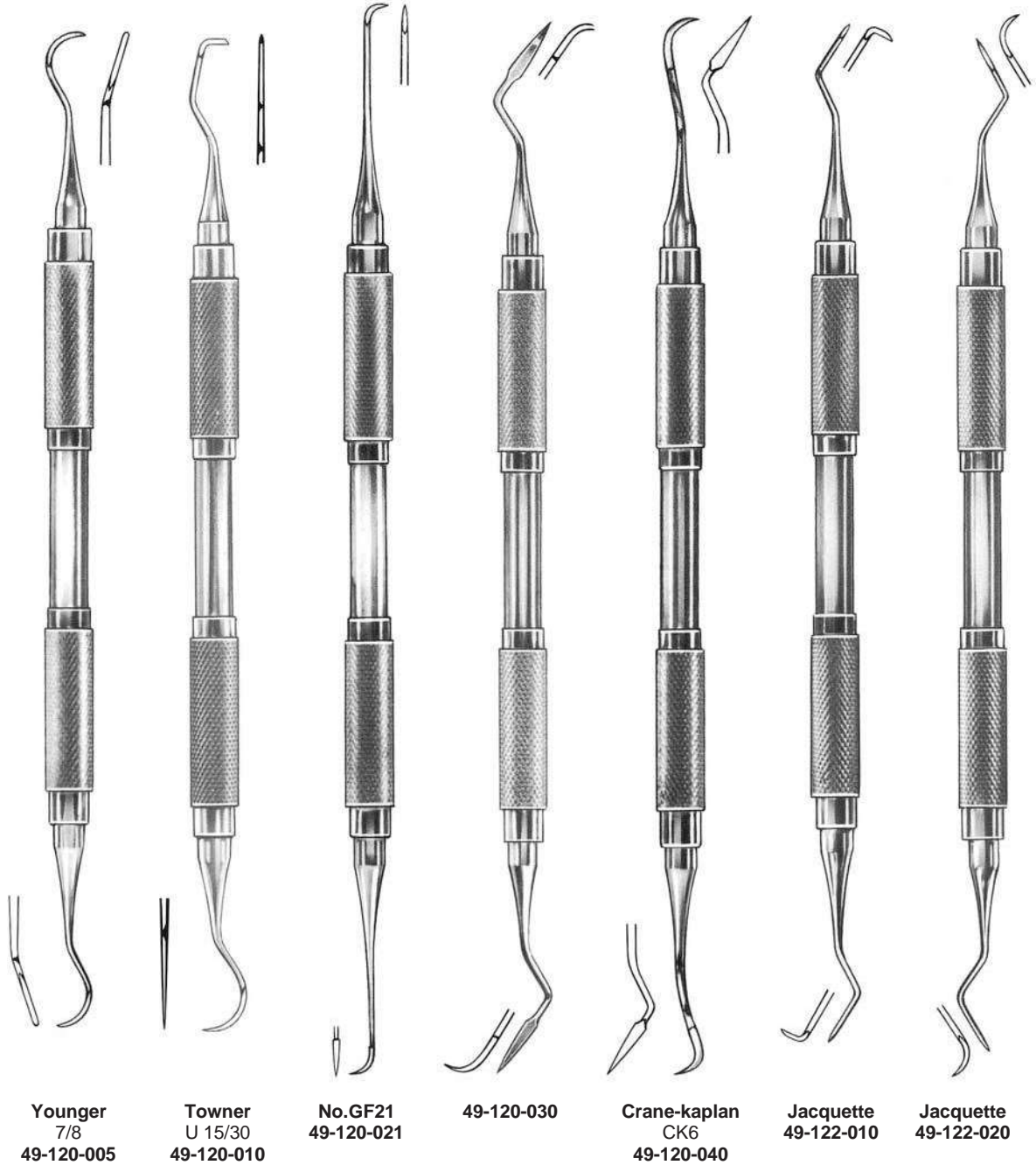

**Younger**  
7/8  
49-120-005

**Towner**  
U 15/30  
49-120-010

**No.GF21**  
49-120-021

**49-120-030**

**Crane-kaplan**  
CK6  
49-120-040

**Jacquette**  
49-122-010

**Jacquette**  
49-122-020

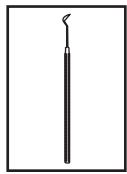

**Prophylactic Curettes**  
 Curettes pour traitement prophylactique  
 Prophylaxe-Zahnreinigungsküretten



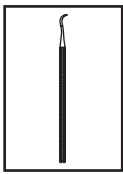

**Periodontal Curettes**  
**Curettes pour la parodontologie**  
**Parodontal-Küretten**

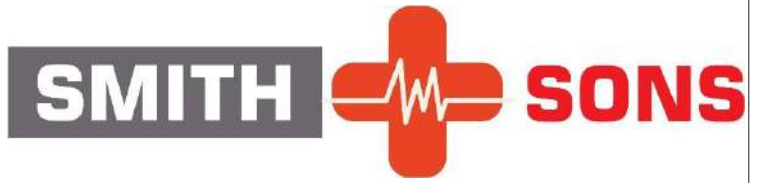

**Gracey**

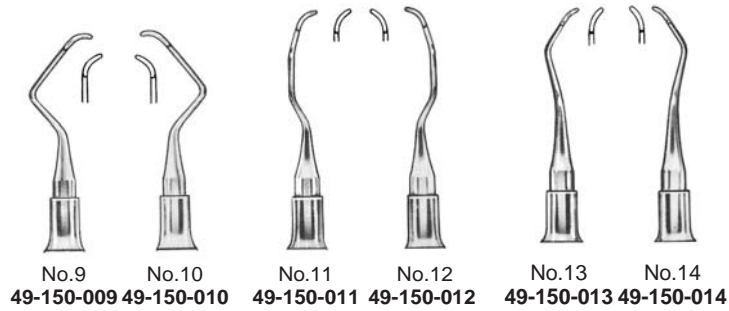
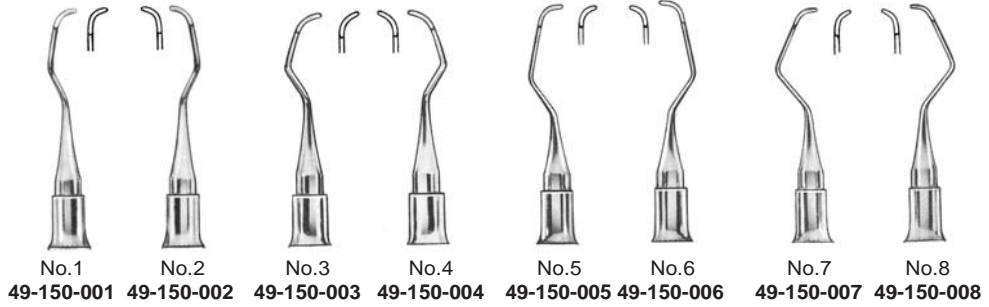

**McCall**

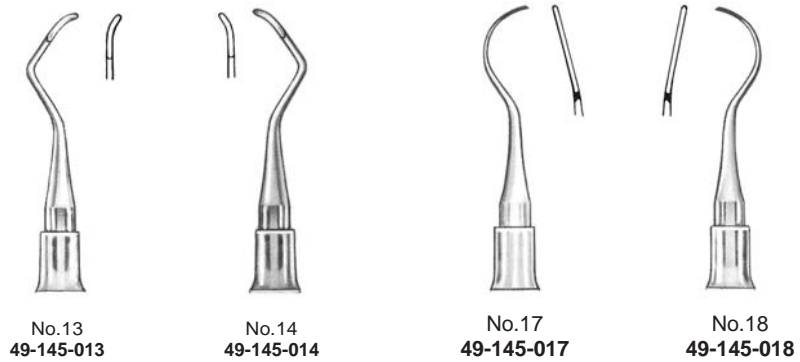

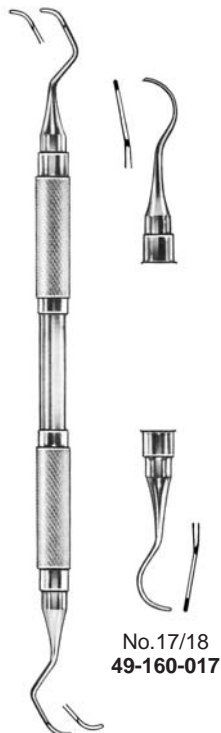
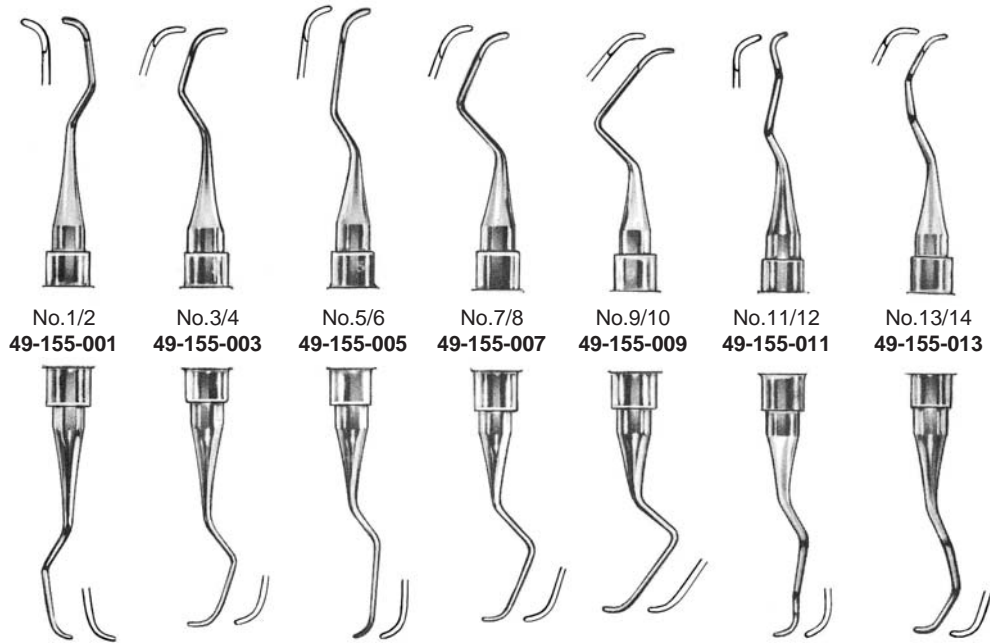
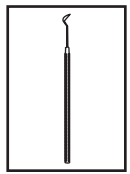

**McCall**  
 No.13/14  
 49-160-013

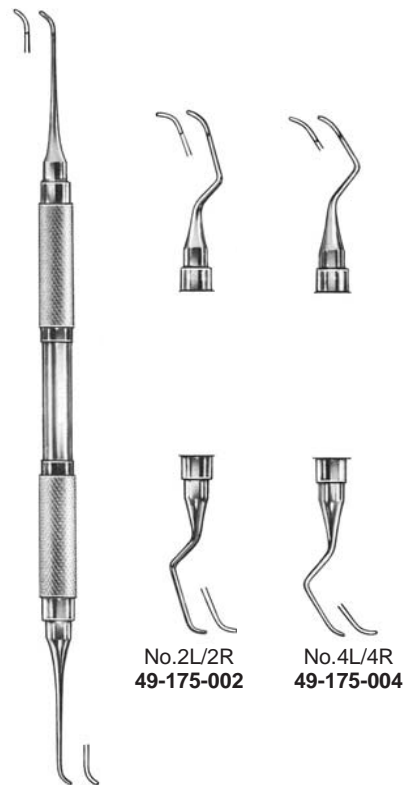

**Columbia University**  
 No.1/2  
 49-175-001



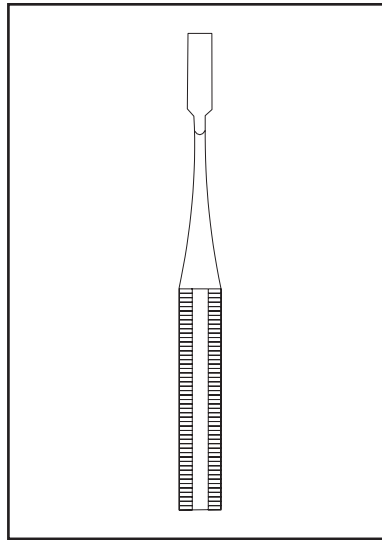

**Enamel Instruments**  
**Instrumentes à émail**  
**Schmeizinstrumente**



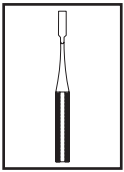

**Enamel Instruments**  
**Instruments à émail**  
**Schmelzinstrumente**



**Black**

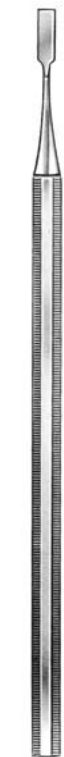
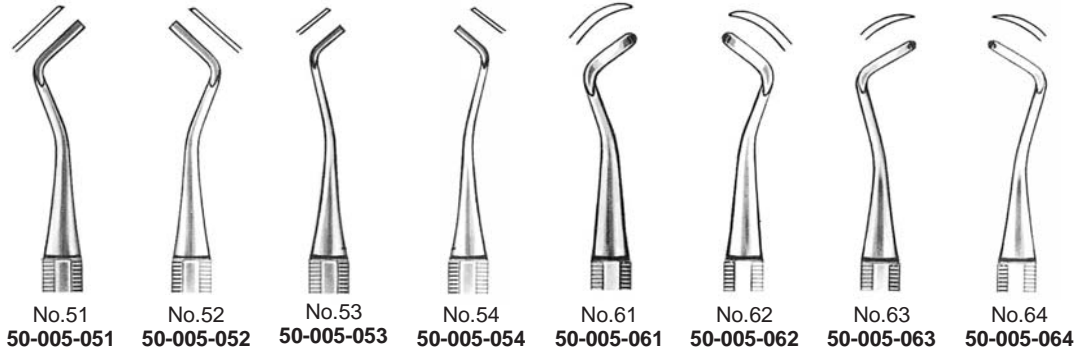

**White**

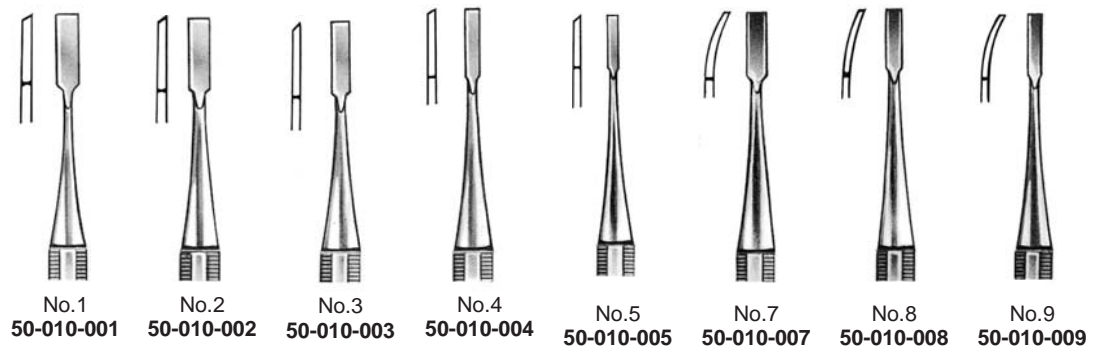

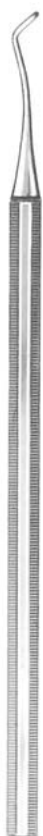
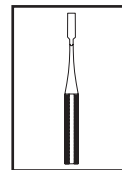

**Black**

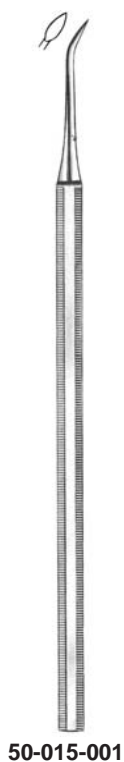
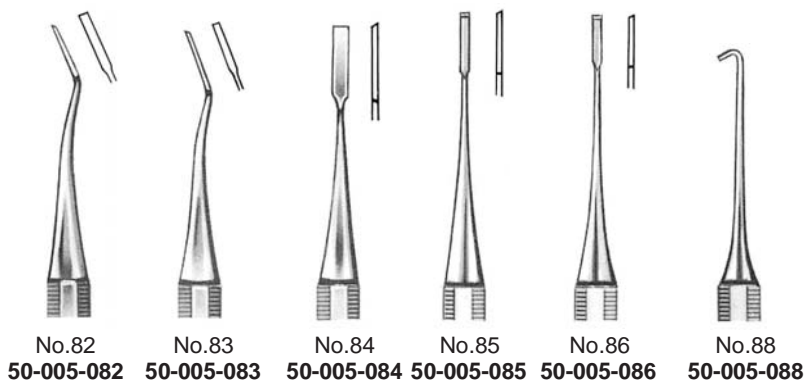
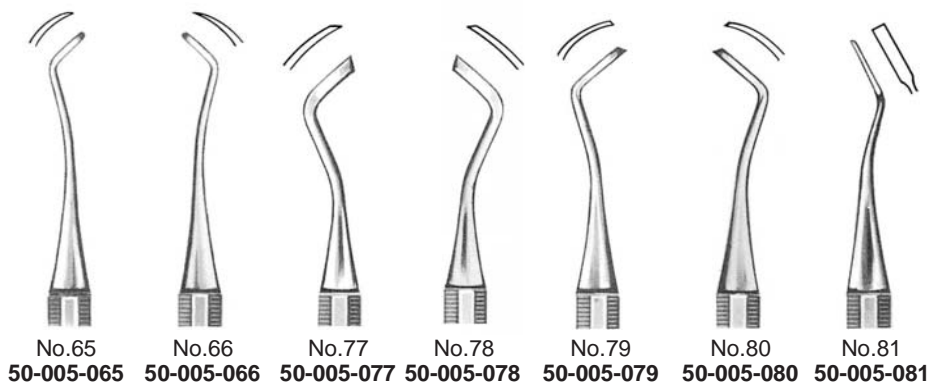

**50-015-001**

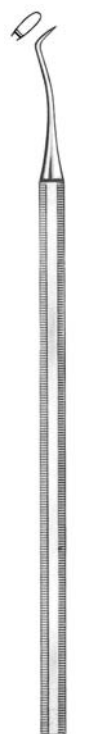

**50-015-002**



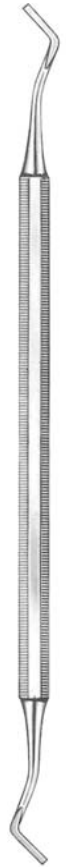
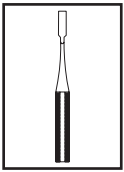

**Black**



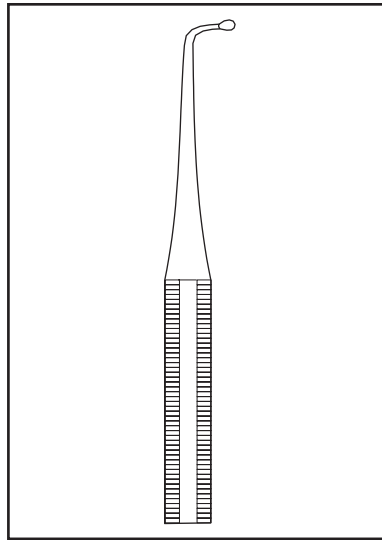

**Excavators**  
Excavateurs  
Exkavatoren



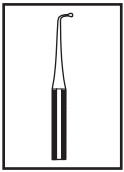

**Excavators**  
**Excavateurs**  
**Exkavatoren**



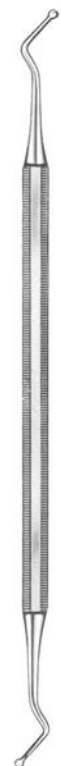

**Ash**

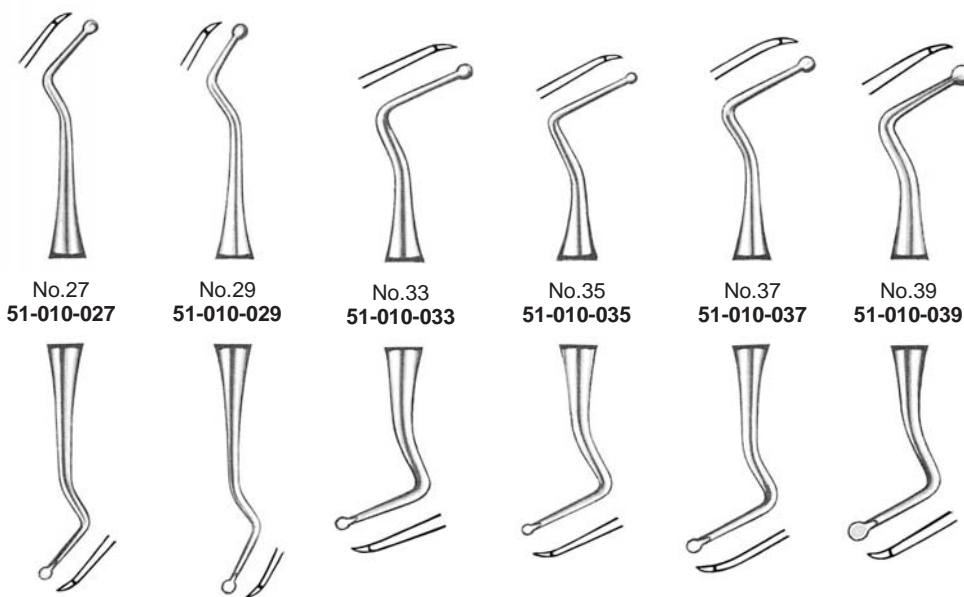

No.27  
51-010-027

No.29  
51-010-029

No.33  
51-010-033

No.35  
51-010-035

No.37  
51-010-037

No.39  
51-010-039

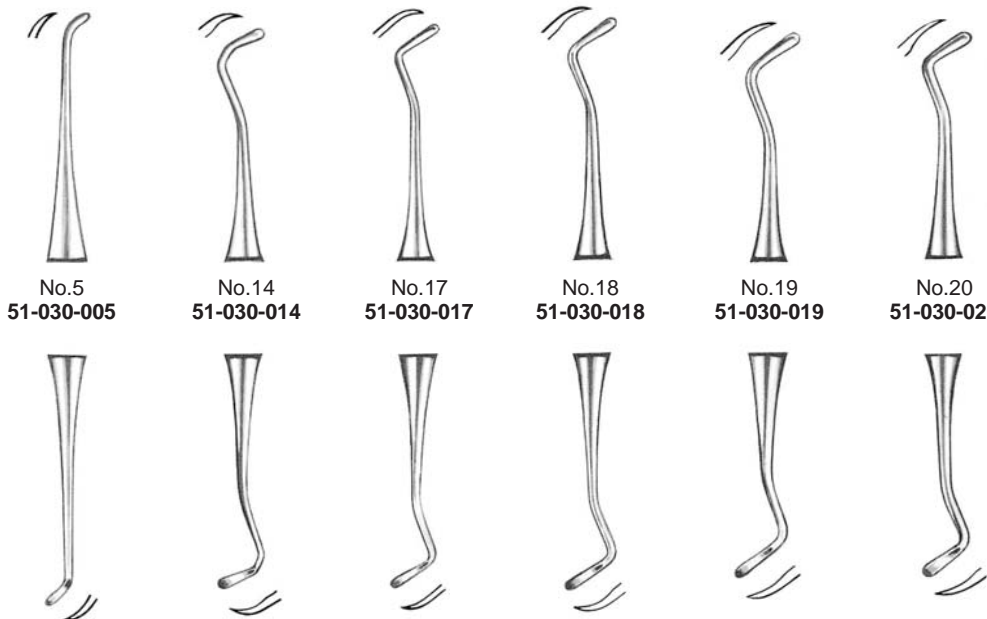

No.5  
51-030-005

No.14  
51-030-014

No.17  
51-030-017

No.18  
51-030-018

No.19  
51-030-019

No.20  
51-030-020

**White**



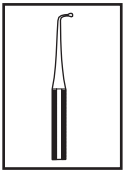

**Excavators**  
**Excavateurs**  
**Exkavatoren**

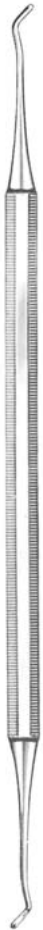

**Darby-Perry**



**No.210/211**  
**51-035-210**



**No.212/213**  
**51-035-212**



**No.214/215**  
**51-035-214**



**No.216/217**  
**51-035-216**



**No.218/219**  
**51-035-218**



**No.220/221**  
**51-035-220**



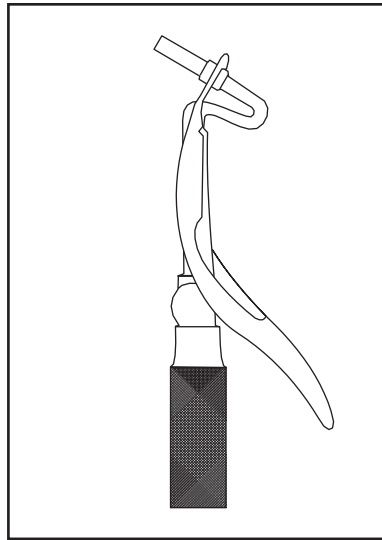

**Amalgam Carriers**  
**Porte-amalgame**  
**Amalgam-Pistolen**



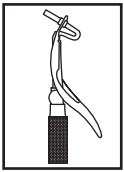

**Amalgam Carriers**  
**Porte-amalgame**  
**Amalgam-Pistolen**



**53-010-001**

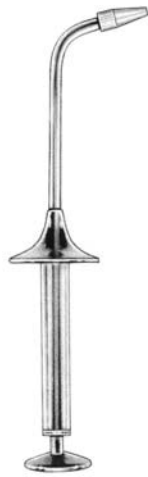

**53-010-002**

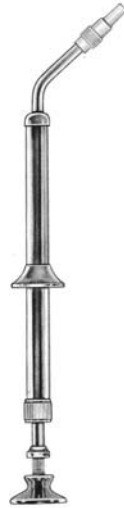

**53-010-004**



**53-010-006**

**Amalgam Well**



**53-030-001**

2 mmø



**Ivory**  
**53-020-001**

2.5 mmø



**Ivory**  
**53-020-002**

2 mmø



**Black**



**No.0**  
**53-035-000**



**No.2**  
**53-035-002**



**No.1**  
**53-035-001**



**No.3**  
**53-035-003**

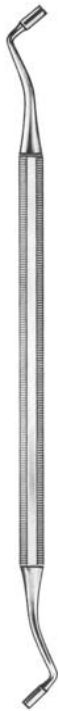
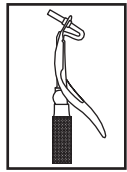

**Black**  
**(Haubeil)**



**No.1**  
**53-040-001**



**No.2**  
**53-040-002**



**No.3**  
**53-040-003**



**No.4**  
**53-040-004**



**Hollenback**  
**No.1**  
**53-050-001**



**No.2**  
**53-050-002**



**No.3**  
**53-050-003**



**No.4**  
**53-050-004**



**No.5**  
**53-050-005**



**No.6**  
**53-050-006**



**No.7**  
**53-050-007**



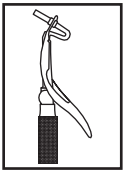

**Amalgam Condensers**  
**Fouloirs à amalgame**  
**Amalgamstopfer**

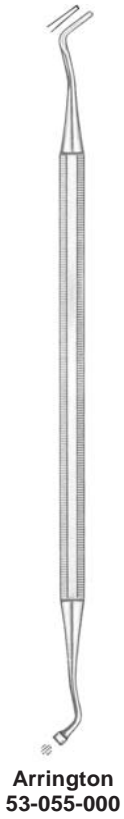

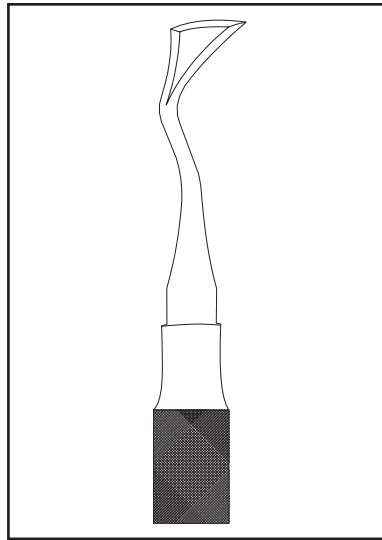

**Gingivectomy Knives**  
**Couteaux à gingivectomie**  
**Gingivektomie-Messer**



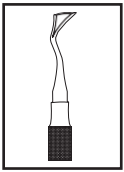

**Gingivectomy Knives**  
**Couteaux à gingivectomie**  
**Gingivektomie-Messer**



**Orban**  
**No.1**  
**55-050-001**



**No.2**  
**55-050-002**



**No.3**  
**55-050-003**



**No.4**  
**55-050-004**



**No.5**  
**55-050-005**



**Sanders**  
**No.1**  
**55-052-001**



**No.2**  
**55-052-002**



**Kirkland**



**No.K15**  
**55-060-015**



**No.K16**  
**55-060-016**



**No.GF7A**  
**55-060-071**



**No.GF7B**  
**55-060-072**

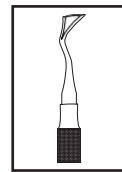

**Kirkland**  
 No.K15/K16  
 55-062-015



**Orban**  
 No. 1/2  
 55-064-012

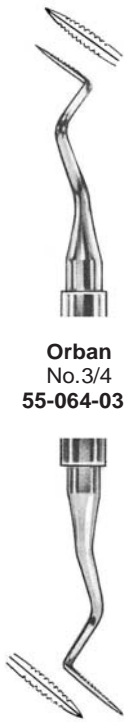

**Orban**  
 No. 3/4  
 55-064-034



**Sanders**  
 No. 1/2  
 55-065-012

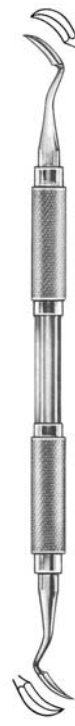

**Crane-Kaplan**  
 No. CK-3  
 55-066-003



**No. GF7**  
 55-070-007



**No. GF8**  
 55-070-008



**No. GF9**  
 55-070-009



**No. GF10**  
 55-070-010



**No. GF11**  
 55-070-011



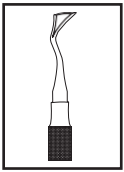

**Periodontal Pocket Probe Gauges**  
**Sondes pour mesurer le cul-de-sac**  
**Zahntaschen-Tiefenmeßsonden**

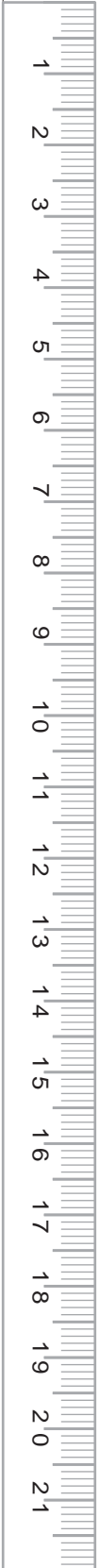

**Weston #35**  
55-071-035



55-071-010



55-071-020



**Fox**  
55-071-030

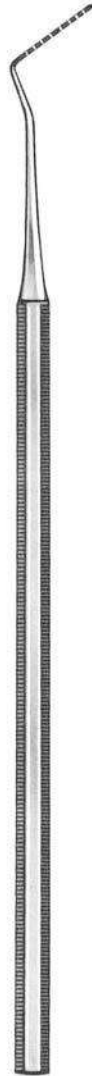

55-071-050



55-071-060



55-071-061



55-071-090

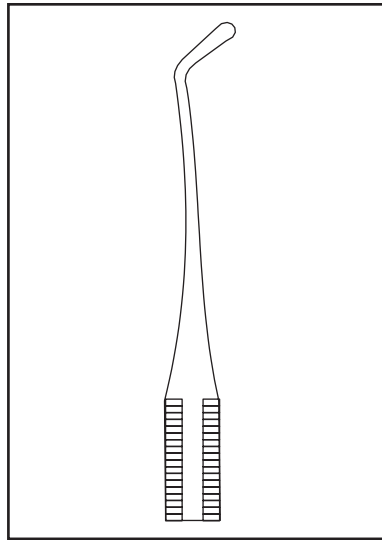

**Filling Instruments**  
**Instruments à plombages**  
**Füllungsinstrumente**



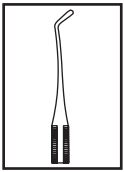

Composite Modelling Instruments  
with Titanium Nitride non-stick protective coating.



Fig.1  
56-008-001



Fig.2  
56-008-002



Fig.3  
56-008-003



Fig.4  
56-008-004



Fig.5  
56-008-005



Fig.6  
56-008-006



Fig.7  
56-008-007



Fig.8  
56-008-008



Fig.9  
56-008-009

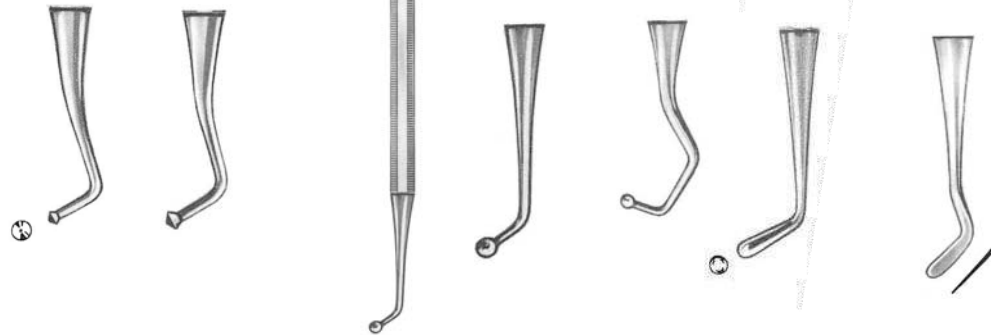
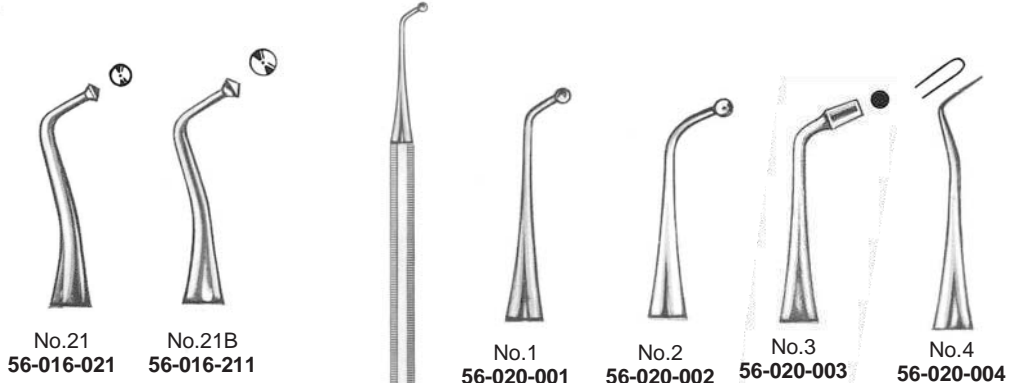
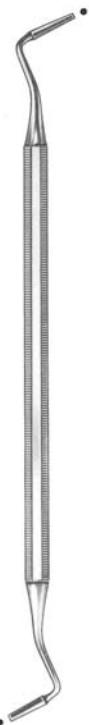
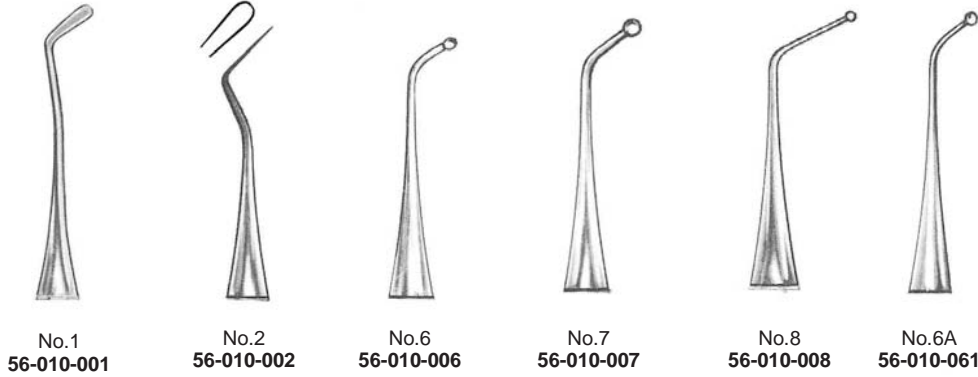
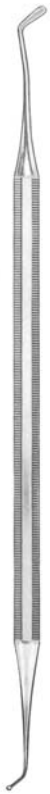
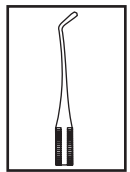

**Mortonsen**  
No.2  
56-016-002

**Wallis**



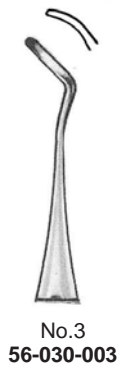
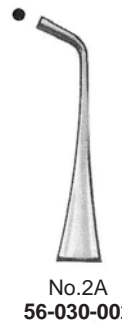
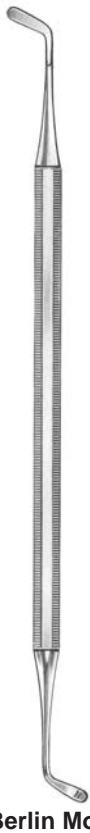
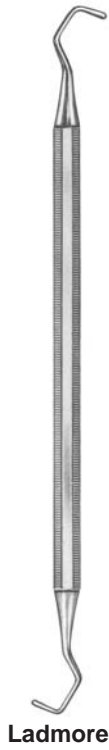
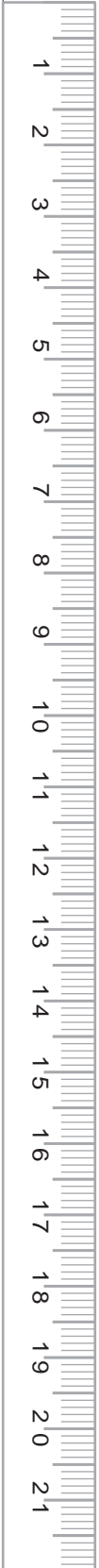
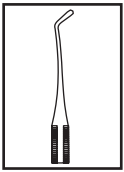

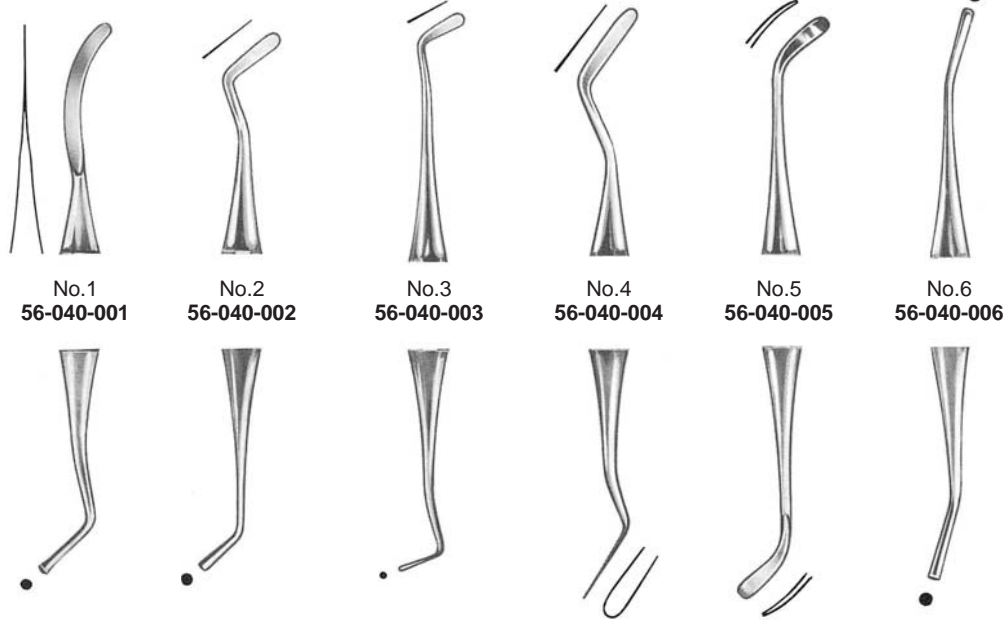
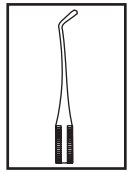

No.1  
56-040-001

No.2  
56-040-002

No.3  
56-040-003

No.4  
56-040-004

No.5  
56-040-005

No.6  
56-040-006

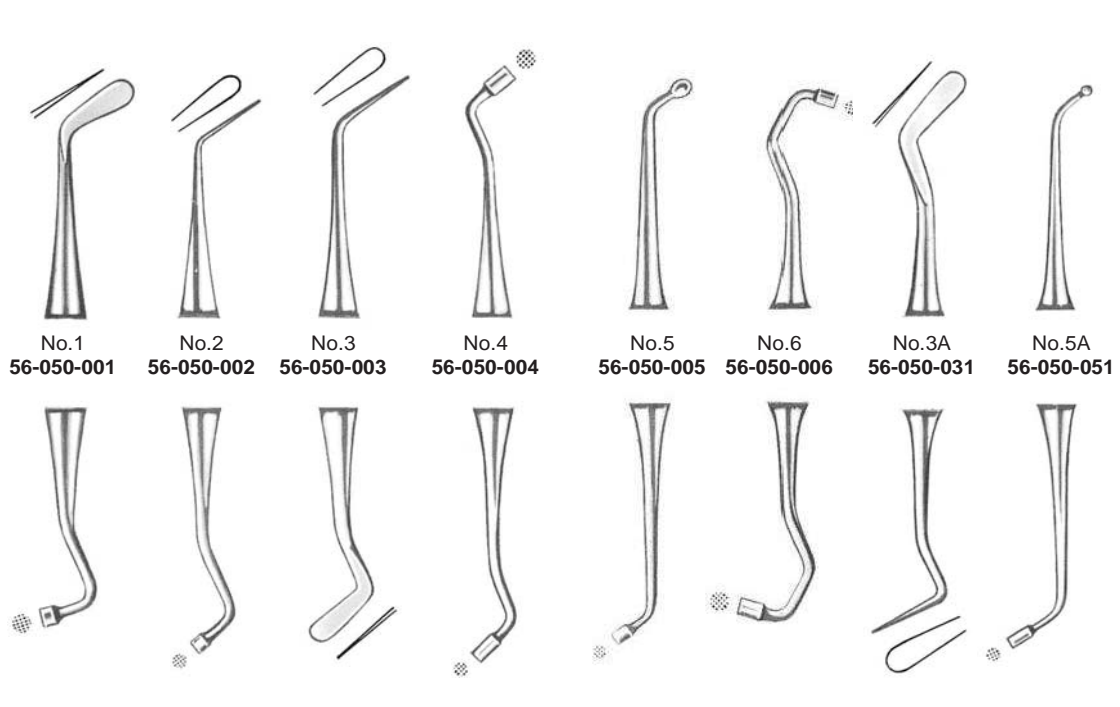

No.1  
56-050-001

No.2  
56-050-002

No.3  
56-050-003

No.4  
56-050-004

No.5  
56-050-005

No.6  
56-050-006

No.3A  
56-050-031

No.5A  
56-050-051



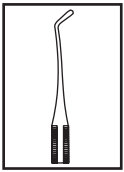

**Filling Instruments**  
**Instruments à plombages**  
**Füllungsinstrumente**

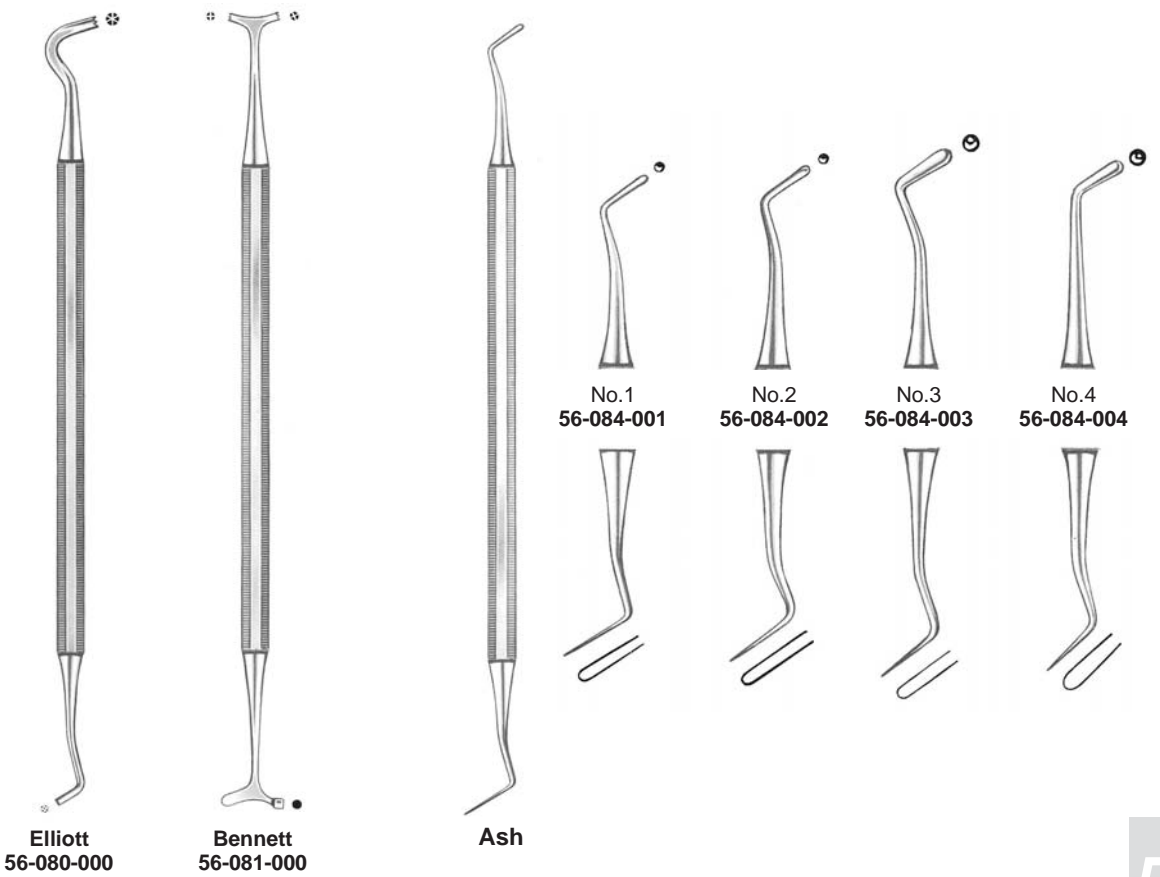
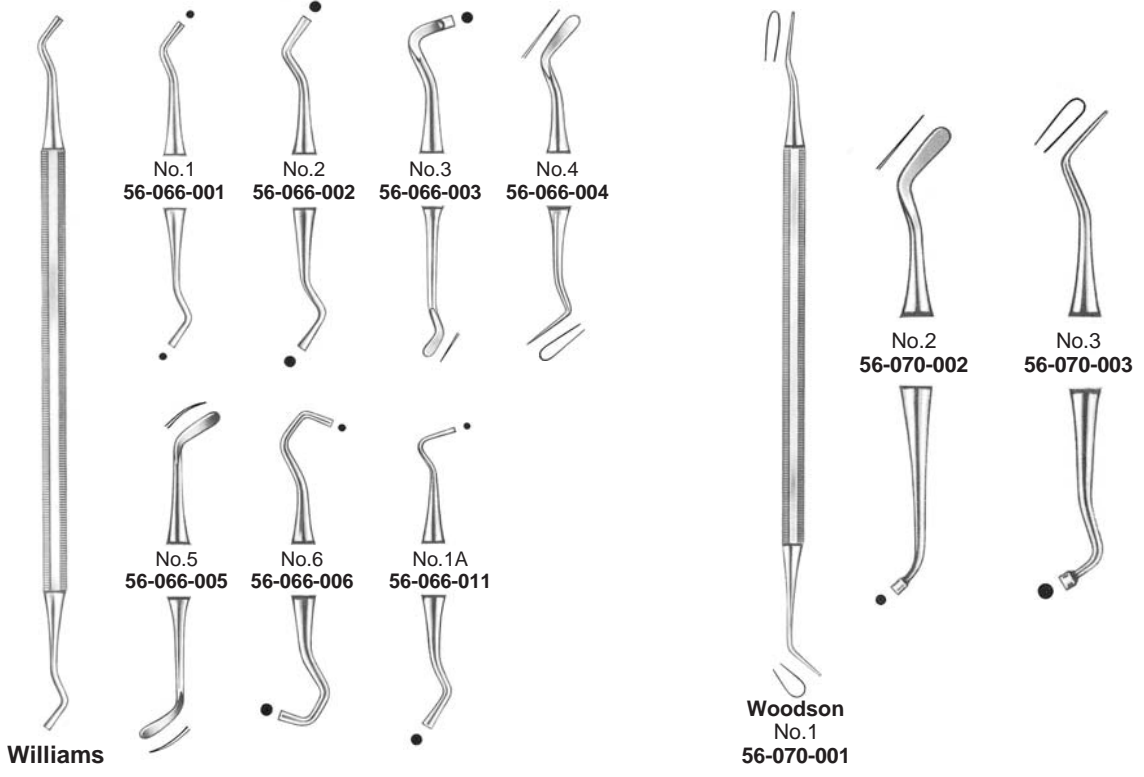

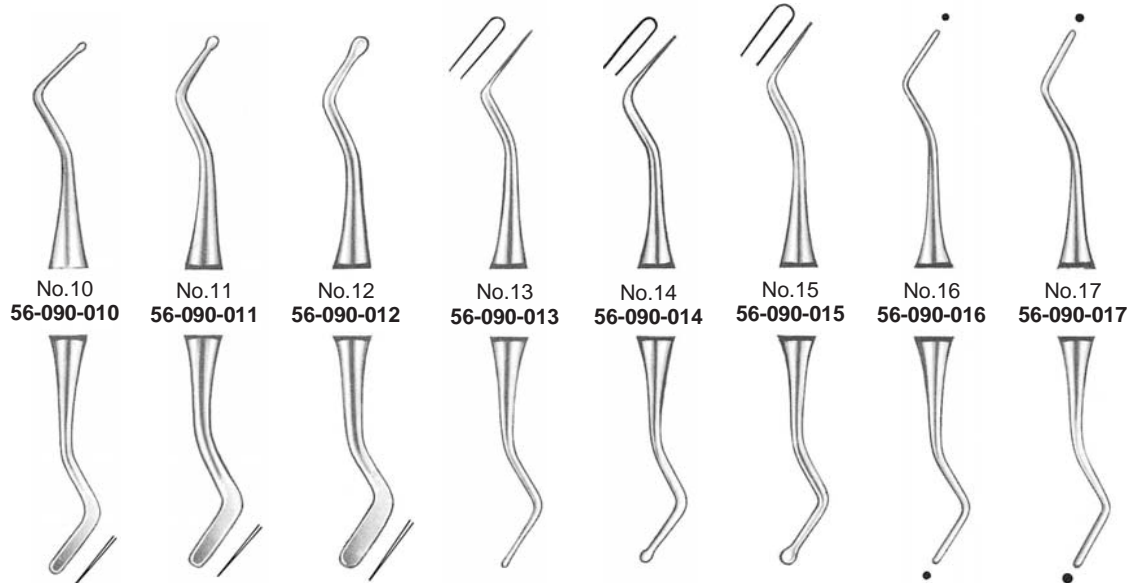
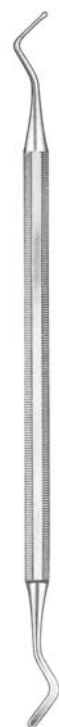
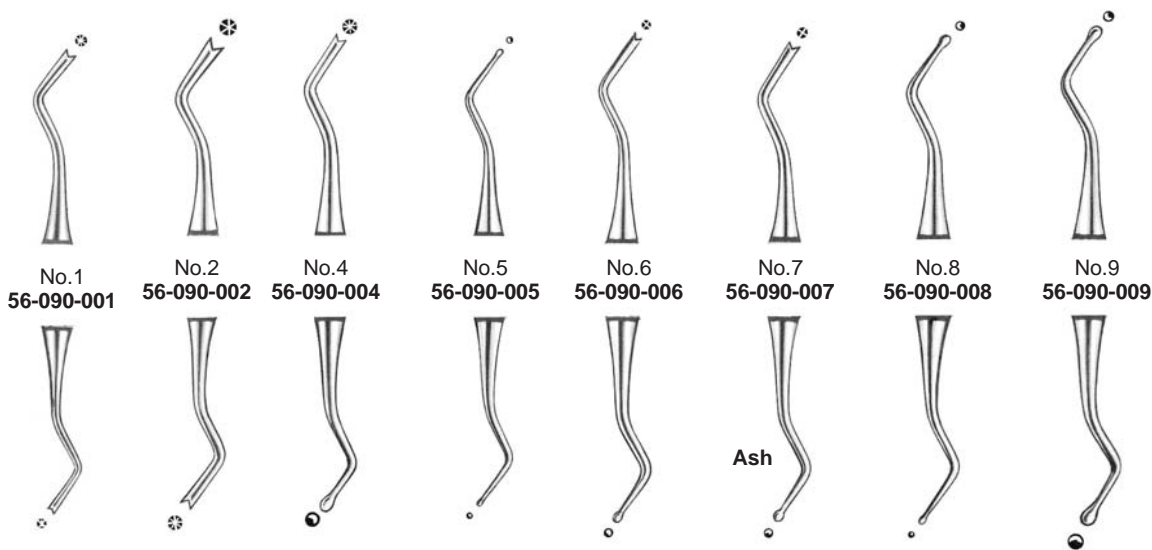
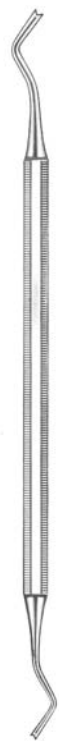
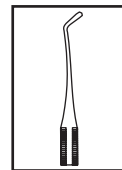

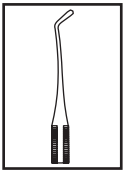

o.18  
56-090-018



No.19  
56-090-019



No.20  
56-090-020



No.22  
56-090-022



No.23  
56-090-023



No.25  
56-090-025



No.26  
56-090-026



No.27  
56-090-027



No.28  
56-090-028



No.31  
56-090-031



No.34  
56-090-034



No.35  
56-090-035



No.36  
56-090-036



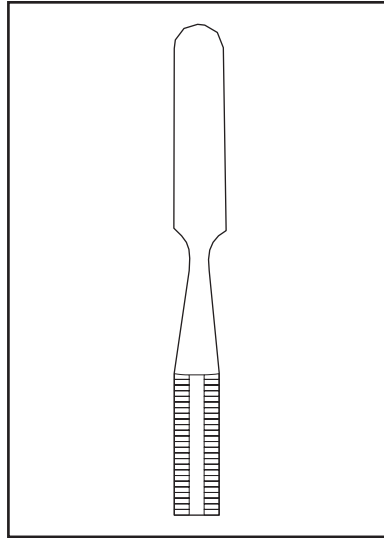

**Cement Spatulas**  
**Spatules á ciment**  
**Zementspatel**



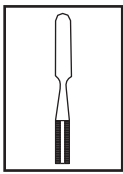

**Cement Spatulas**  
 Spatules á ciment  
 Zementspatel

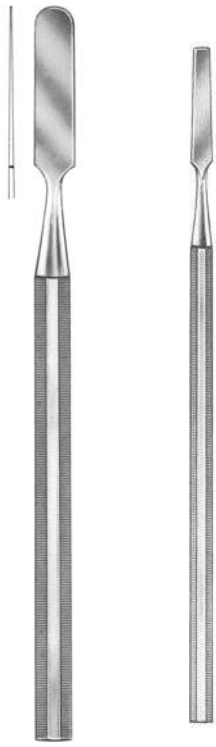

57-010-000

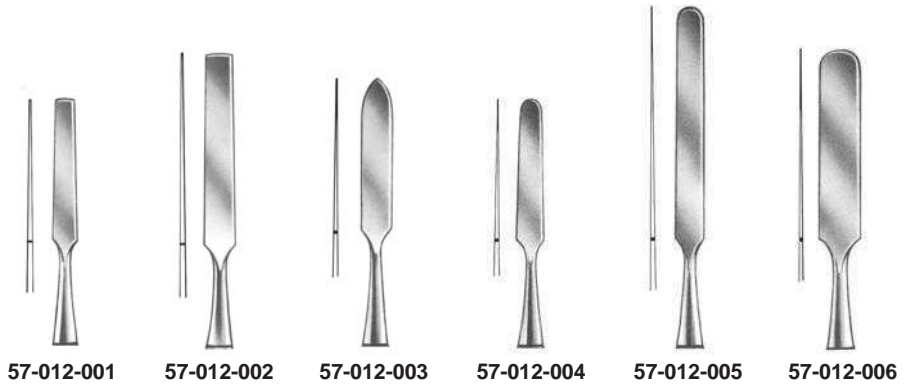

**Cement Spatula Double Ended**

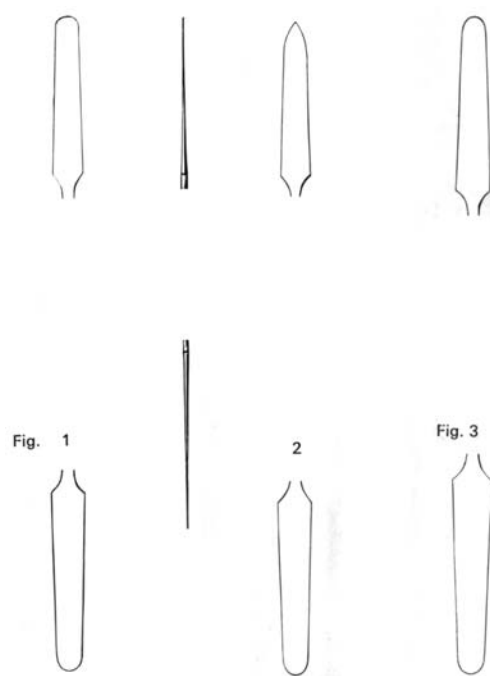

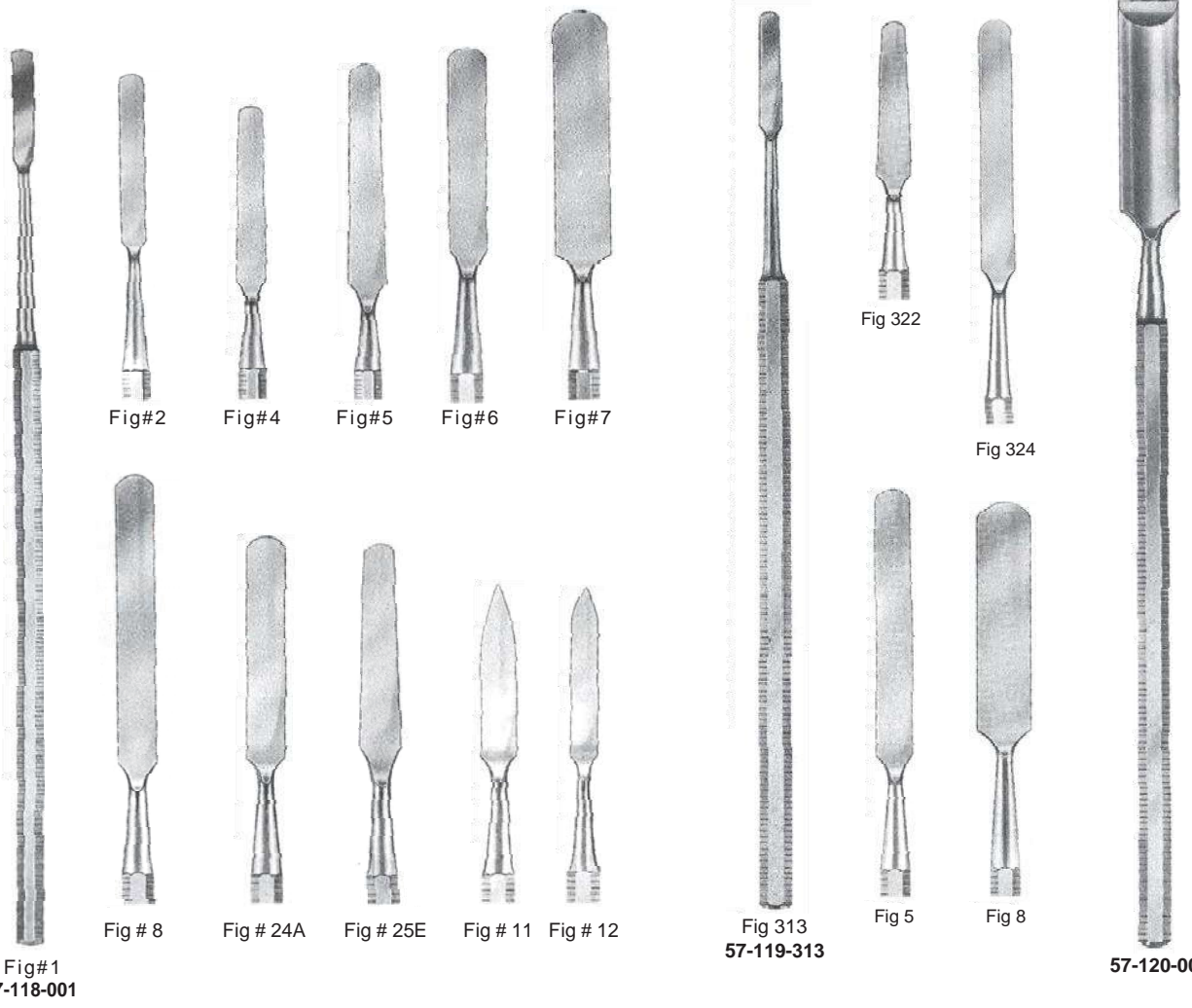
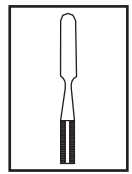
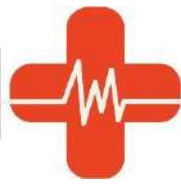

**Fig#1**  
**57-118-001**

**Fig#2**

**Fig#4**

**Fig#5**

**Fig#6**

**Fig#7**

**Fig 322**

**Fig 324**

**Fig # 8**

**Fig # 24A**

**Fig # 25E**

**Fig # 11**

**Fig # 12**

**Fig 313**  
**57-119-313**

**Fig 5**

**Fig 8**

**57-120-00**



**Fig 3**  
**57-121-003**



**Fig 5**  
**57-121-005**

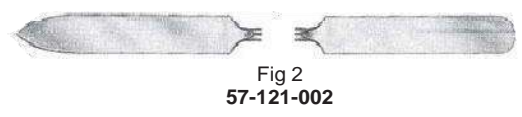

**Fig 2**  
**57-121-002**



**Fig 4**  
**57-121-004**



**Fig 1**  
**57-121-001**

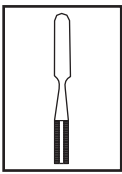

**Cement Spatulas**  
**Spatules á ciment**  
**Zementspatel**

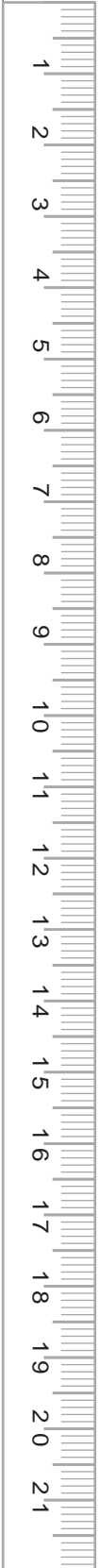

Fig 1  
57-122-001



Fig 2  
57-122-002



Fig 3  
57-122-003

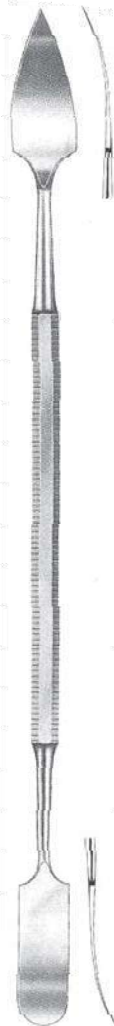

Fig 31  
GRITMAN  
57-123-000



Fig 1  
57-24-001



Fig 2



Fig 3



Fig 4



Fig 5



Fig 6



Fig 7



Fig 2  
57-125-002



Fig 3  
57-125-003



Fig 1  
57-125-001

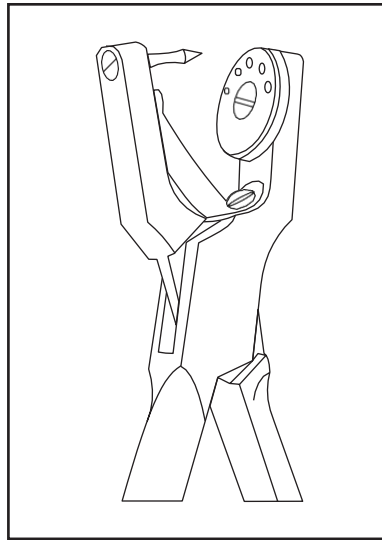

**Matrix Retainers & Matrix Bands**  
**Porte-matrices et matrices**  
**Matrizenspanner und Matrizenbänder**





**NYSTRÖM**  
No.1  
58-010-001



**Ivory**  
No.1  
58-030-001



**Ivory**  
No.12  
58-030-012

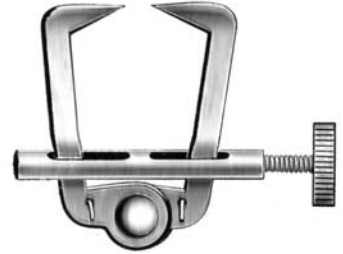

**Elliot**  
58-021-002

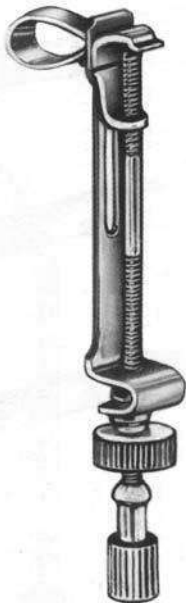

**Ivory**  
No.8  
5 mm  
58-030-005



**Universal**  
Tofflemire  
58-020-001



**Junior**  
Tofflemire  
58-020-000



**Senior**  
Tofflemire  
58-020-002

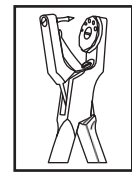

**Ivory**  
 16 cm/ 6¼"  
 58-110-160



**Ainsworth**  
 17 cm/ 6¾"  
 58-110-170

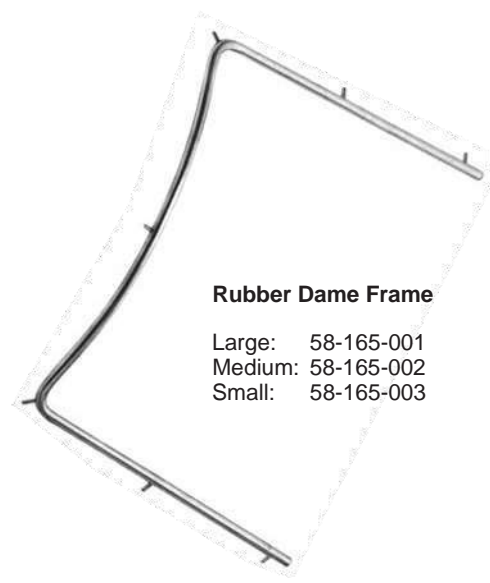

**Rubber Dame Frame**

- Large: 58-165-001
- Medium: 58-165-002
- Small: 58-165-003

**Rubber Dam Clamps**



58-170-026



58-170-027



58-170-028



58-170-029



58-170-030



58-170-031



58-170-051



58-170-060

**Template Sheet SS**

58-172-010





**Rubber Dam Clamps Forceps**  
**Pinces porte-crampons**  
**Kofferdam-Klammerzangen**



**Palmer**  
 17 cm/ 6¾"  
 58-120-170



**Stockes**  
 17 cm/ 6¾"  
 58-122-170



**Palmer**  
 17 cm/ 6¾"  
 58-124-170

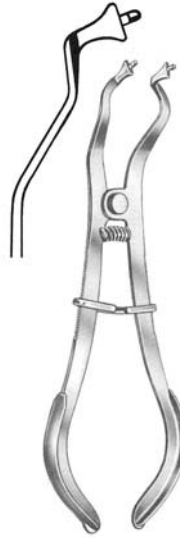

**Ivory**  
 17 cm/ 6¾"  
 58-152-170

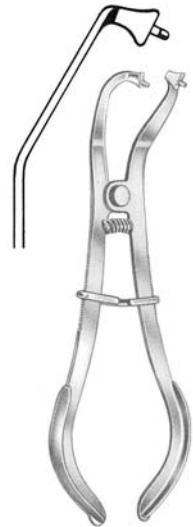

**Ivory**  
 17 cm/ 6¾"  
 58-150-170

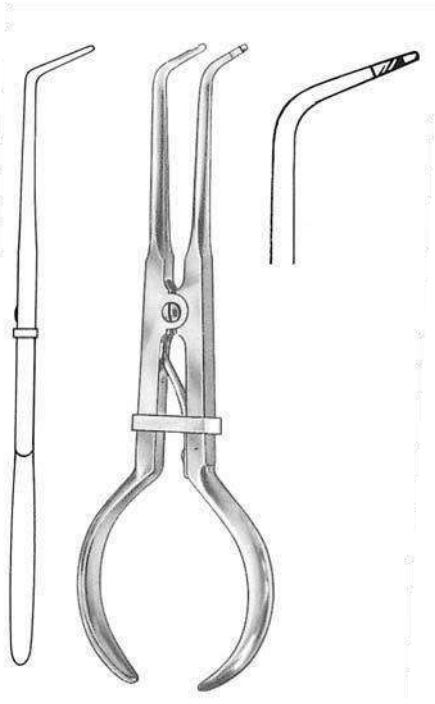

**Norwegian Pattern**  
 17 cm/ 6¾"  
 58-160-170

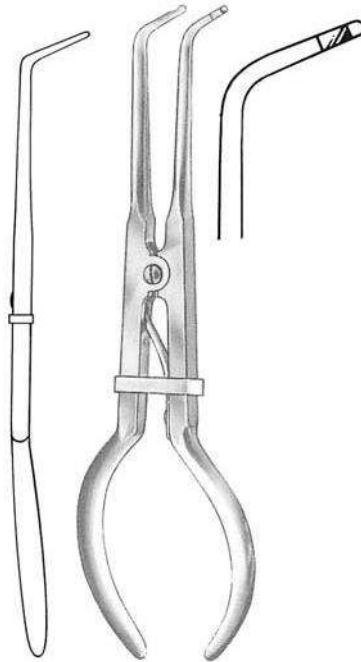

**Swedish Pattern**  
 17 cm/ 6¾"  
 58-162-170

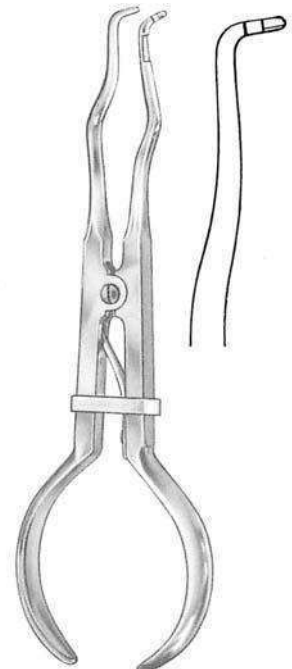

**Brewer**  
 17 cm/ 6¾"  
 58-164-170

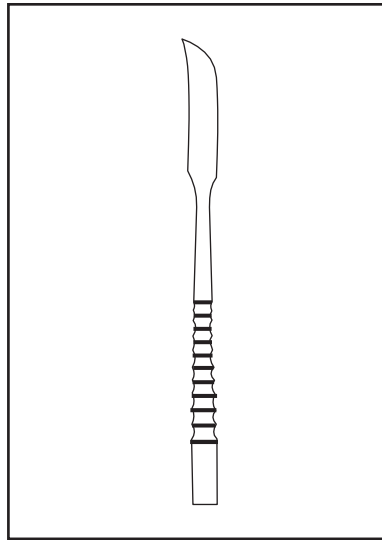

**Modelling Instruments**  
**Instruments à modeler**  
**Modellierinstrumente**



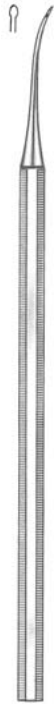
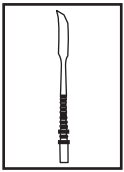

**Nyström**  
**59-010-001**

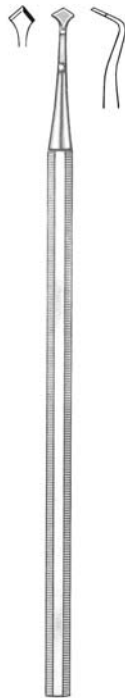

**Frahm**  
**No.2**  
**59-012-002**

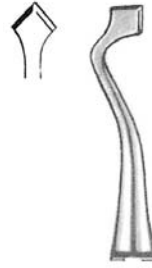

**Frahm**  
**No.6**  
**59-012-006**



**Frahm**  
**No.10**  
**59-012-010**



**Nyström**  
**59-020-000**



**Ward**  
**No.1**  
**59-022-001**



**Ward**  
**No.2**  
**59-022-002**



**Hollenback**  
**59-024-000**

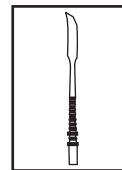

**Hyllin**  
59-032-000



**Zahle**  
59-034-000



**Lecron**  
59-040-002



**Lecron**  
59-040-001



**Lecron**  
59-040-003



**Vehe**  
59-052-001



**Vehe**  
59-052-002

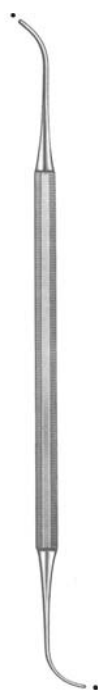

**P.K. Thomas**  
No.1  
59-210-001



**P.K. Thomas**  
No.2  
59-210-002



**P.K. Thomas**  
No.3  
59-210-003



**P.K. Thomas**  
No.4  
59-210-004



**P.K. Thomas**  
No.5  
59-210-005



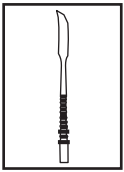

**Modelling Instruments**  
**Instruments à modeler**  
**Modellierinstrumente**



**Roach**  
59-250-000



**Frahm**  
59-251-000



**Mehlum**  
59-252-000



**Riegner**  
59-260-000



**Beale**  
59-261-000



**Gritmann**  
59-262-000



**Fahnenstock**  
59-270-001



**Fahnenstock**  
59-270-002



**Lessmann**  
59-272-001



**Lessmann**  
59-272-002



18cm, 7¼"  
59-280-180



**Gritman**  
17cm, 6¾"  
59-282-170



22cm, 8¾"  
59-284-220

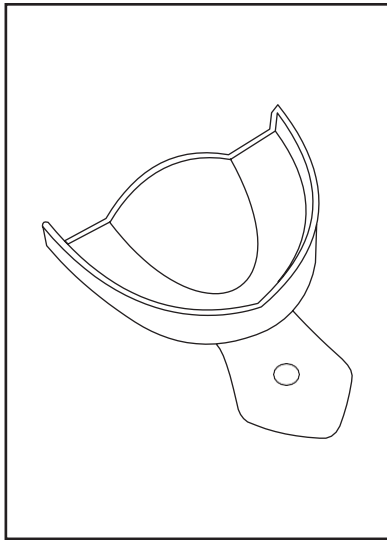
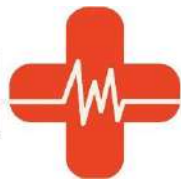

**Impression Trays**  
**Porte-empreintes**  
**Abdrucklöffel**

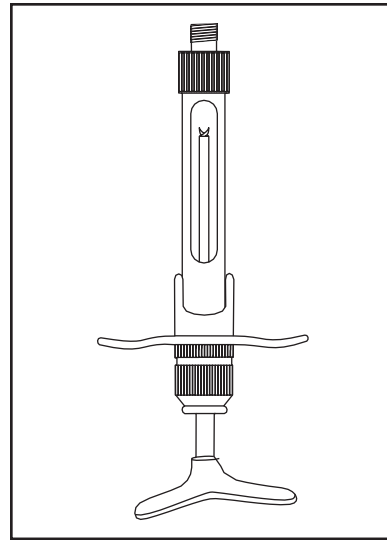

**Syringes**  
**à carpules**  
**Ampullen spritze**



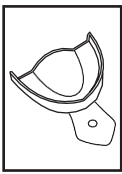

**Solid Partial Set of 10**

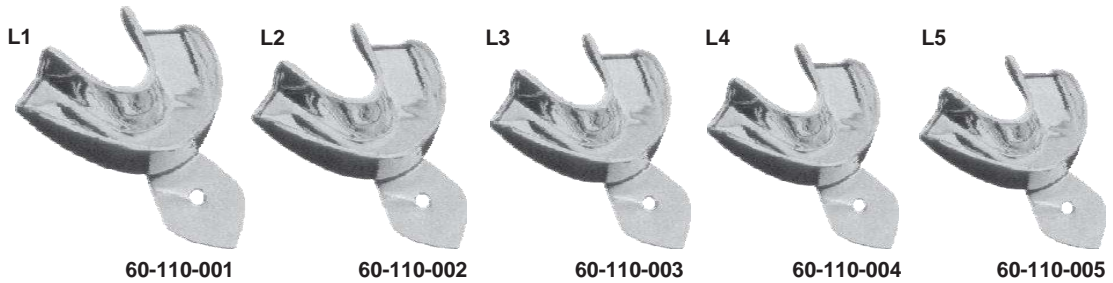
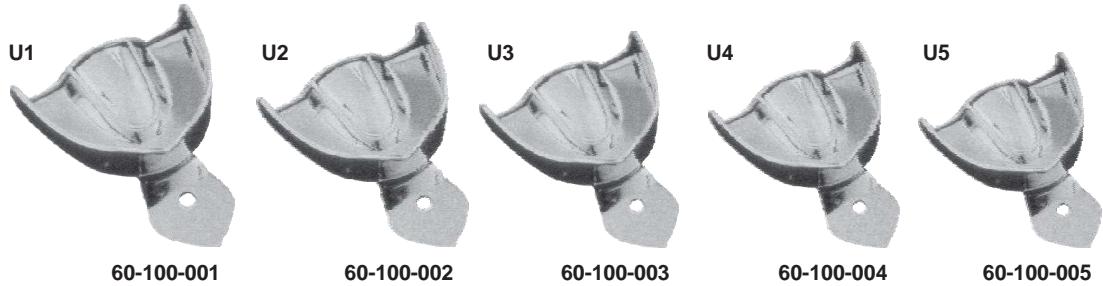

**Perforated Partial Set of 10**

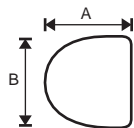
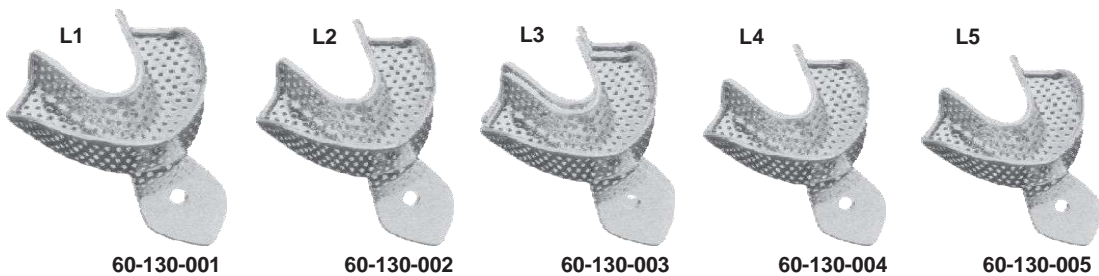
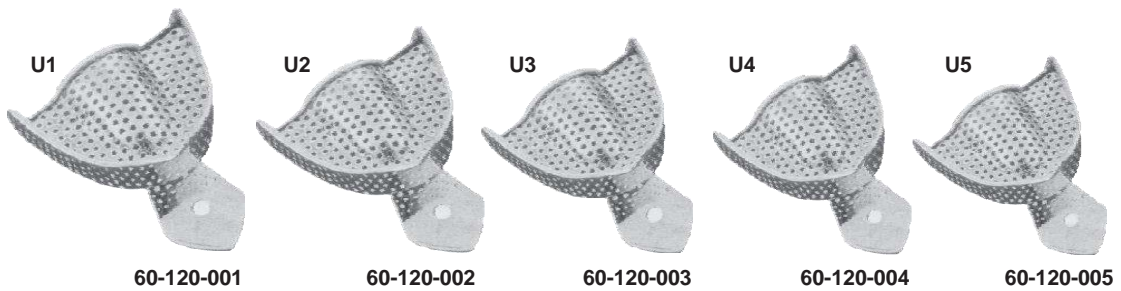

UPPER (mm)	U1	U2	U3	U4	U5
	A	62	60	53	54
B	83	75	73	69	68

LOWER (mm)	L1	L2	L3	L4	L5
	A	63	61	57	60
B	82	81	78	74	71

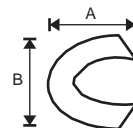

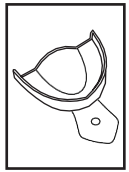

**Solid Full Denture Set of 8**

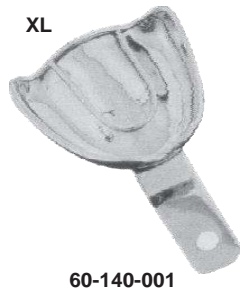

**Perforated Full Denture Set of 10**

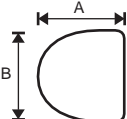

	<b>UPPER</b> (mm)	XL	L	M	S	
		A	70	67	64	60
		B	79	76	70	73

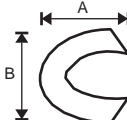
	<b>LOWER</b> (mm)	XL	L	M	S	
		A	64	64	60	57
		B	86	70	73	70



**Solid Set of 6**

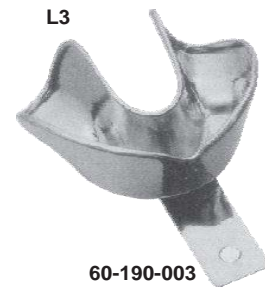
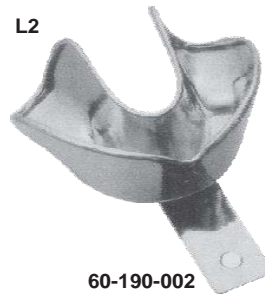
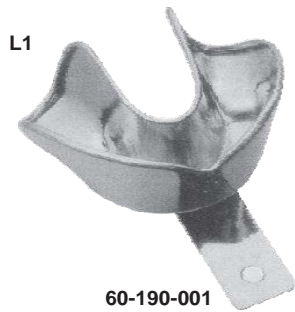
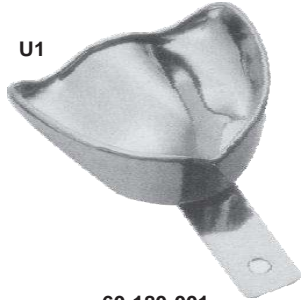

**Perforated Set of 6**

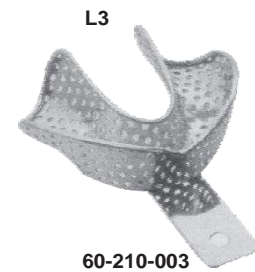
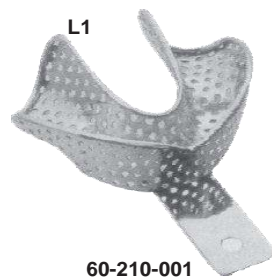
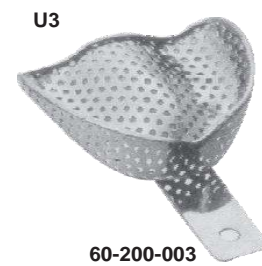
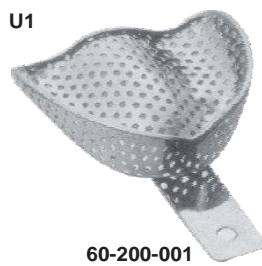

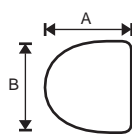
	<b>UPPER</b> (mm)	U1	U2	U3	
		A	67	64	57
		B	81	71	70

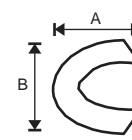
	<b>LOWER</b> (mm)	L1	L2	L3	
		A	60	64	54
		B	81	79	76

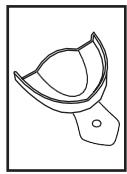

**English Pattern**

**Set of 8**



**60-220-001**  
Lower



**60-230-001**  
Upper

**Set of 8**

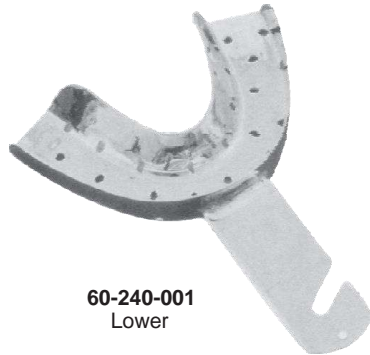

**60-240-001**  
Lower



**60-250-001**  
Upper

**Set of 8**



**60-260-001**  
Lower



**60-270-001**  
Upper



UPPER	Size	A	B	C
	0	67	50	12
1	72	51	13	
2	78	55	15	
3	80	58	15	

LOWER	Size	A	B	C
	0	70	51	14
1	77	51	15	
2	79	55	16	
3	80	60	17	



**Impression Trays**  
 Porte-empreintes  
 Abdrucklöffel



**60-280-001**

For upper right jaw  
 For lower left jaw



**60-290-001**

For upper left jaw  
 For lower right jaw

Available in 4 Sizes

1	44 mm
2	55 mm
3	60 mm
4	65 mm



Bite Gauge  
**60-300-030**

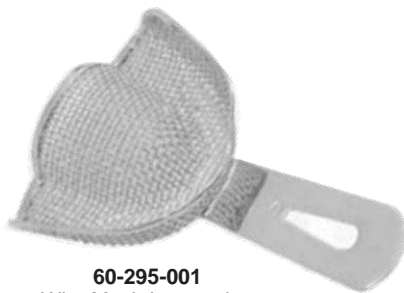

**60-295-001**  
 Wire Mesh Impression  
 Tray Brass Made



**60-860-000**



**60-860-001**

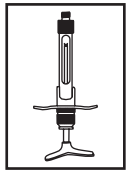

ml 1.8  
**60-810-000**  
ml 2.2  
**60-810-001**



ml 1.8  
**60-814-000**  
ml 2.2  
**60-814-001**



ml 1.8  
**60-820-000**  
ml 2.2  
**60-820-001**



ml 1.8  
**60-824-000**  
ml 2.2  
**60-824-001**



ml 1.8  
**60-840-000**  
ml 2.2  
**60-840-001**



ml 1.8  
**60-850-000**  
ml 2.2  
**60-850-001**

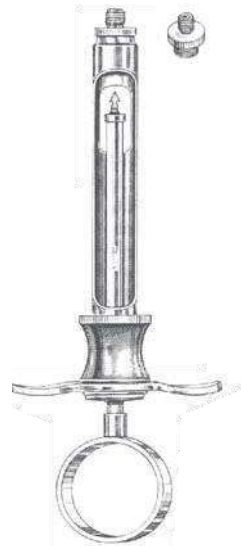

**C-TYPE  
ASPIRATING SYRINGE**  
**60-855-000** 1.8 CC  
**60-855-001** 2.2CC

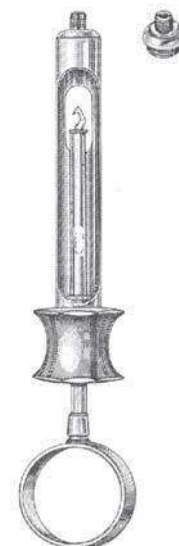

**A-TYPE  
ASPIRATING SYRINGE**  
**60-856-000** 1.8 CC  
**60-856-001** 2.2CC



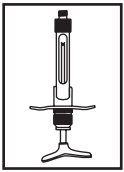

Intra Ligamental Syringes  
Intra Ligamental à carpules  
Intra Ligamentalen Ampullen spritze



**60-870-000**



**60-880-000**

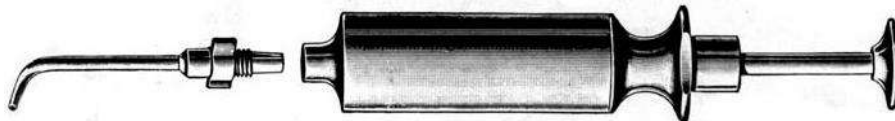

Water Syringe  
**60-881-001**

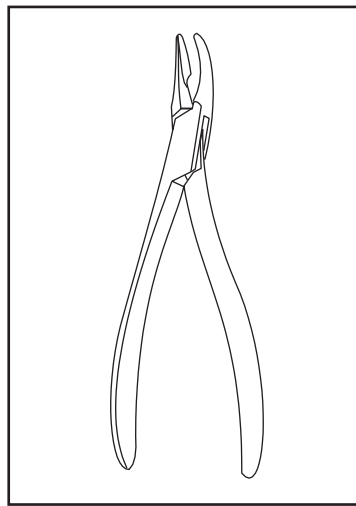

**Orthodontic Pliers**  
**Pinces d'atelier**  
**Zahntechnische Zangen**



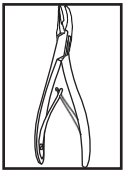

## INSERTED PLIERS

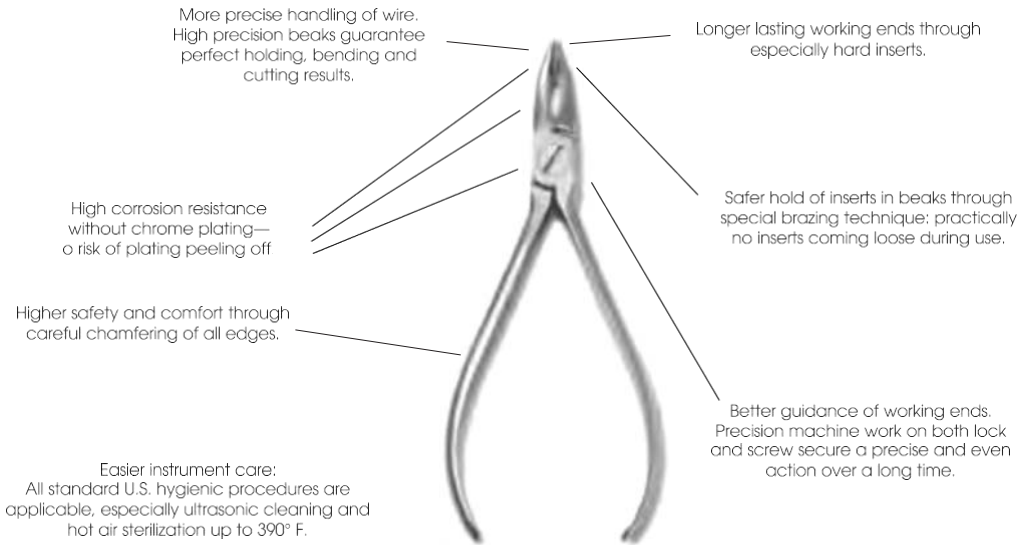

## NON-INSERTED PLIERS

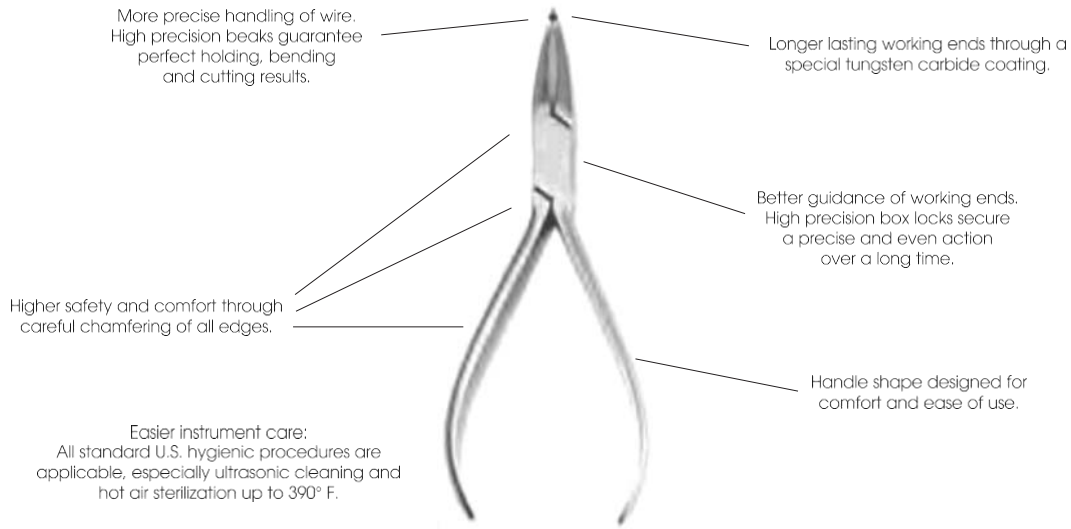

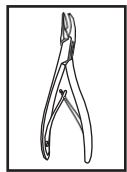

**61-4001-000**  
 Young Plier



**61-4002-000**  
 Laboratory Plier  
 Smooth



**61-4003-000**  
 Robinson Plier



**61-4004-000**  
 Reynolds Plier



**61-4005-000**  
 How Plier



**61-4006-000**  
 Goslee Plier



**61-4007-000**  
 Laboratory Plier  
 Serrated



**61-4008-000**  
 Pessio Plier



**61-4009-000**  
 Johnson Plier



**61-4010-000**  
 Three Jaw Plier-Large



**61-4011-000**  
 Gordon Plier



**61-4012-000**  
 Three Jaw Plier-Large  
 Curved



Curved



**61-4013-000**  
 Concaved Clasp  
 Bending Pliers, Straight



Straight



**BOX SELECTION**



Box Lock=B/L



Screw Lock Box=S/L



Allen Wrench Box=AW/L

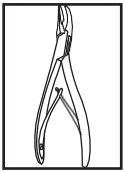

**Clasp Foring Pliers**



**61-4014-000**  
Type-I



**61-4015-000**  
Type-II



**61-4018-002**  
Type # 2

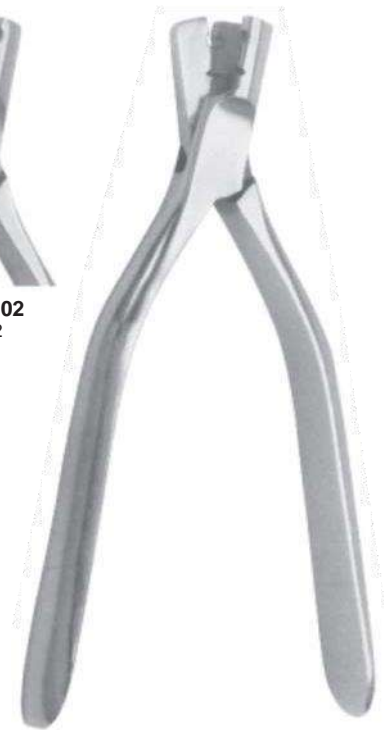

**61-4018-000**  
BAR BENDERS  
Type # 1



**61-4016-000**  
Type-III



**61-4017-000**  
Type-IV



**61-4019-000**  
BAR BENDERS

**BOX SELECTION**



Box Lock=B/L



Screw Lock Box=S/L



Allen Wrench Box=AW/L

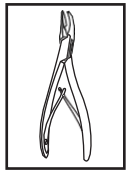

**61-4020-TC**  
Distal End Safety Cutter  
-Slim (Long Handle)  
**Maximum Cutting Capacity**  
■ Rectangular Wires up to .022 x .028"  
● Round Wires up to .020"  
▼ Brided Wires up to .016"



**61-4021-TC**  
Distal End Safety Cutter  
-Slim  
**Maximum Cutting Capacity**  
■ Rectangular Wires up to .022 x .028"  
● Round Wires up to .020"  
▼ Brided Wires up to .016"



By regular distal end safety cutter



By distal end safety cutter flush cut type

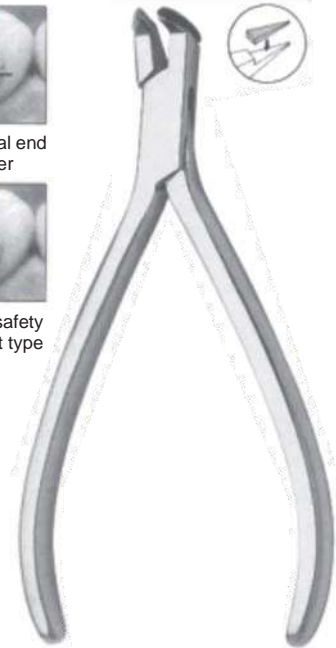

**61-4023-TC**  
Distal End Safety Cutter  
-Slim (Flush Cut Type)  
**Maximum Cutting Capacity**  
■ Rectangular Wires up to .022 x .028"  
● Round Wires up to .020"  
▼ Brided Wires up to .021 x .025



**61-4022-TC**  
Distal End Safety Cutter  
**Maximum Cutting Capacity**  
■ Rectangular Wires up to .022 x .028"  
● Round Wires up to .020"  
▼ Brided Wires up to .016"



**61-4024-TC**  
Pin & Ligature Cutter  
**Maximum Cutting Capacity**  
Ligature Wires up to .016"  
Elastic Ligatures



**61-4025-TC**  
Distal End Cutter  
-Non Hold  
**Maximum Cutting Capacity**  
■ Rectangular Wires up to .022 x .028"



**61-4026-TC**  
Pin & Ligature Cutter-Miniature  
**Maximum Cutting Capacity**  
Ligature Wires up to .016"  
Elastic Ligatures

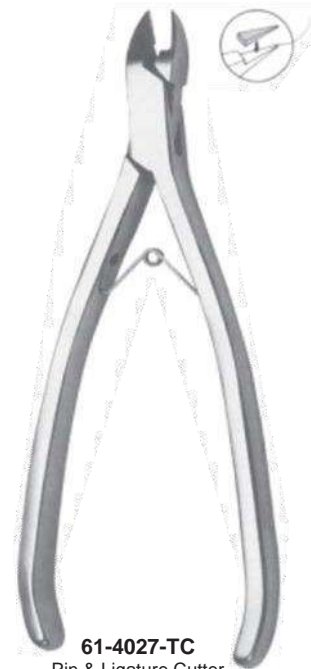

**61-4027-TC**  
Pin & Ligature Cutter  
-Slim (Long Handle)  
**Maximum Cutting Capacity**  
Ligature Wires up to .015"  
Elastic Ligatures



### BOX SELECTION



Box Lock=B/L



Screw Lock Box=S/L



Allen Wrench Box=AW/L

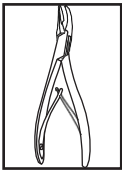

**Orthodontic Pliers**  
**Pinces d'atelier**  
**Zahntechnische Zangen**



**61-4028-TC**  
 Pin & Ligature Cutter  
**Maximum Cutting Capacity**  
 Soft Wires up to .015"

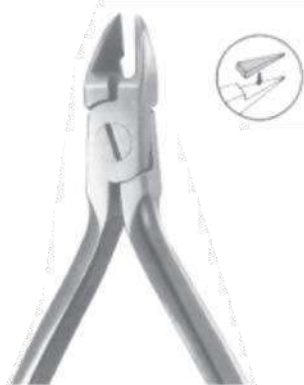

**61-4029-TC**  
 Pin & Ligature Cutter-Miniature  
**Maximum Cutting Capacity**  
 Soft Wires up to .015"



**61-4030-TC**  
 Pin & Ligature Cutter-Slim  
**Maximum Cutting Capacity**  
 Soft Wires up to .015"



**61-4031-TC**  
 Pin & Ligature Cutter-45°Angel  
**Maximum Cutting Capacity**  
 Soft Wires up to .015"



**61-4032-TC**  
 Hard Wire Cutters  
**Maximum Cutting Capacity**  
 Hard Wires up to .020" Round

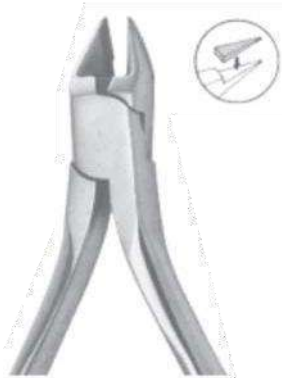

**61-4033-TC**  
 Pin & Ligature Cutters  
**Maximum Cutting Capacity**  
 Ligature Wires up to .016"  
 Elastic Ligature

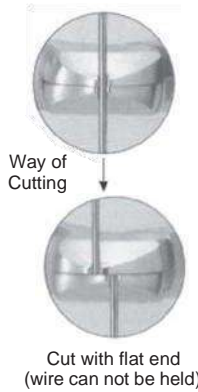

Way of Cutting  
 Cut with flat end  
 (wire can not be held)



**61-4034-000**  
 Power Cutters  
**Maximum Cutting Capacity**  
 Hard Wires & Soft Wires  
 up to 1.5mm

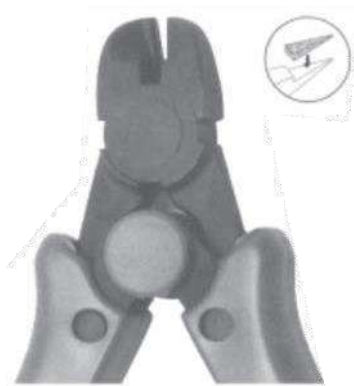

**61-4035-TC**  
 Wire Hold Cutters  
**Maximum Cutting Capacity  
 & Holding Capacity**  
 Hard Wires of 0.7mm to 1.2mm



**61-4036-000**  
 Flat Cutters  
**Maximum Cutting Capacity**  
 Cut at Top ~ 1.00mm  
 Cut at Side ~ 1.2mm

**BOX SELECTION**



Box Lock=B/L



Screw Lock Box=S/L



Allen Wrench Box=AW/L

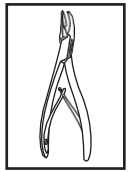

**61-4037-000**  
How Plier-Titanium Alloy  
With Special coated beaks



**61-4038-000**  
How Plier  
Tips are 1/8" (3.2mm)  
diameter



**61-4039-000**  
How Plier  
Tips are 1/8" (3.2mm)  
diameter



**61-4040-000**  
How Plier-Small  
Tips are 3/32" (2.4mm)  
diameter



**61-4041-000**  
How Plier-Offset  
Tips are 1/8" (3.2mm)  
diameter



**61-4042-000**  
Weingart Utility Plier  
-Titanium Alloy  
with special coated beaks



**61-4043-000**  
Weingart Utility Plier  
New Type of the Weingart Utility Plier  
designed for a more precise operation.

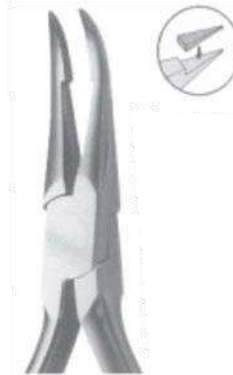

**61-4044-TC**  
Weingart Utility Plier



**61-4045-000**  
Weingart Utility Plier

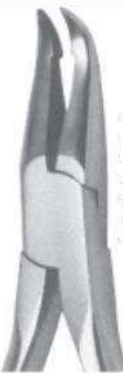

**61-4046-TC**  
Weingart Utility Plier



**61-4047-TC**  
Bird Beak Plier with Cutter  
**Maximum Bending & Cutting Capacity**  
Wires upto .032"

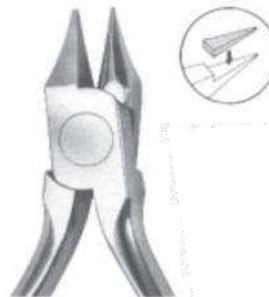

**61-4048-TC**  
Bird Beak Plier  
**Maximum Bending Capacity**  
Wires upto .032"



**61-4049-000**  
Bird Beak Plier  
**Maximum Bending Capacity**  
Wires upto .030"



### BOX SELECTION



Box Lock=B/L



Screw Lock Box=S/L



Allen Wrench Box=AW/L

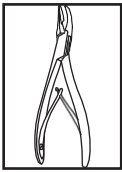

**Orthodontic Pliers**  
**Pinces d'atelier**  
**Zahntechnische Zangen**

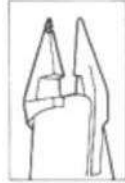

**61-4050-TC**  
 Light Wire Plier with Cutter  
 -Grooved Square Tip  
**Maximum Bending & Cutting Capacity**  
 Wires up to .020"

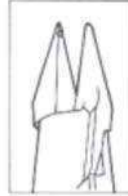

**61-4051-TC**  
 Light Wire Plier with Cutter  
 -Grooved Square Tip  
**Maximum Bending Capacity**  
 Wires up to .020"



**61-4052-000**  
 Light Wire Plier with Cutter  
 -Grooved Square Tip  
**Maximum Bending Capacity**  
 Wires up to .018"



**61-4053-TC**  
 Light Wire Plier with Cutter  
**Maximum Bending & Cutting Capacity**  
 Wires up to .020"



**61-4054-TC**  
 Light Wire Plier  
**Maximum Bending Capacity**  
 Wires up to .020"



**61-4055-000**  
 Light Wire Plier  
**Maximum Bending Capacity**  
 Wires up to .018"



**61-4056-000**  
 Begg Light Wire Plier  
**Maximum Bending Capacity**  
 Wires up to .016"



**61-4057-000**  
 Young Plier  
**Maximum Bending Capacity**  
 Wires up to .040"



**61-4058-000**  
 Jarabak Plier  
**Maximum Bending Capacity**  
 Wires up to .020"



**61-4059-000**  
 Tweed Loop Forming Plier  
**Maximum Bending Capacity**  
 Wires up to .022"



**61-4060-000**  
 Omega Loop Forming Plier  
**Maximum Bending Capacity**  
 Wires up to .022"



**61-4061-000**  
 Loop Forming Plier  
**Maximum Bending Capacity**  
 Wires up to .022"

**BOX SELECTION**



Box Lock=B/L



Screw Lock Box=S/L



Allen Wrench Box=AW/L

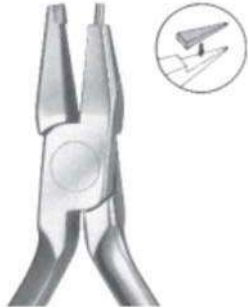
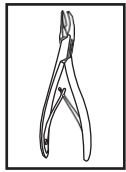

**61-4062-TC**  
Quad Helix Bending Plier  
**Maximum Bending Capacity**  
Wires up to .036"



**61-4063-TC**  
Tweed Loop Forming Plier  
**Maximum Cutting Capacity**  
Rectangular Wires up to .022 x .028"



**61-4064-TC**  
Kim Plier with Cutter  
**Maximum Cutting Capacity**  
Rectangular Wires up to .016 x .022"



**61-4065-000**  
Nancy Closing Loop Plier  
**Maximum Bending Capacity**  
Wires up to .022"



**61-4066-000**  
Tweed Arch Bending Plier  
**Maximum Cutting Capacity**  
Rectangular Wires up to .022 x .028"



**61-4067-TC**  
Tweed Arch Bending Plier  
**Maximum Cutting Capacity**  
Rectangular Wires up to .022 x .028"

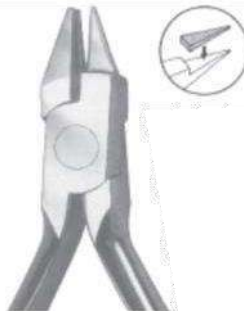

**61-4068-TC**  
Three Jaw Plier  
**Maximum Bending Capacity**  
Wires up to .028"



**61-4069-000**  
Three Jaw Plier  
**Maximum Bending Capacity**  
Wires up to .028"



**61-4070-000**  
Heavy Three Jaw Plier  
**Maximum Bending Capacity**  
Wires up to .036"



**61-4071-000**  
Adams Plier  
**Maximum Bending Capacity**  
Wires up to .030"



**61-4072-000**  
Adams Plier  
**Maximum Bending Capacity**  
Wires up to .040"



**61-4073-000**  
Stop Plier  
**Maximum Bending Capacity**  
Wires up to .025"



**61-4074-TC**  
Heavy Wire Bending Plier  
**Maximum Bending Capacity**  
Wires up to .047" (1.2mm)

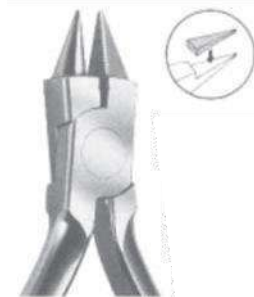

**61-4071-000**  
Adams Plier  
**Maximum Bending Capacity**  
Wires up to .028" (0.7mm)

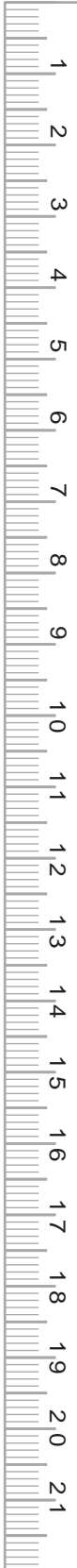

### BOX SELECTION



Box Lock=B/L



Screw Lock Box=S/L



Allen Wrench Box=AW/L

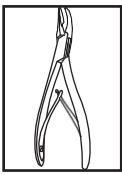

**Orthodontic Pliers**  
**Pinces d'atelier**  
**Zahntechnische Zangen**



**61-4076-000**  
 Head-Gear Plier  
**Maximum Bending Capacity**  
 Wires up to .051"(1.3mm)



**61-4077-000**  
 Head-Gear Plier  
**Maximum Bending Capacity**  
 Wires up to .051"(1.3mm)

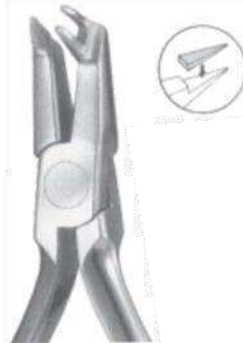

**61-4078-TC**  
 Angel Three Jaw-Left

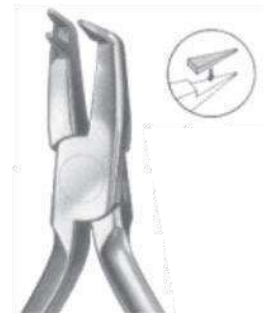

**61-4079-TC**  
 Angel Three Jaw-Right



**61-4080-TC**  
 Arch Forming Plier  
 -Grooved



**61-4081-TC**  
 Arch Forming Plier  
 -Non Grooved



**61-4082-TC**  
 Ligature Forming Plier



**61-4086-000**  
 Bracket Placing  
 Tweezers



**61-4083-000**  
 Hollow Chop Plier  
**Maximum Bending Capacity**  
 Wires up to .022"



**61-4084-000**  
 Tube Crimping Plier



**61-4085-000**  
 Hook Crimping Plier  
 For use in quick and precise  
 placement of the hook on the archwire.



**61-4087-000**  
 Boon Bracket Positioning  
 Gauge

**BOX SELECTION**



Box Lock=B/L



Screw Lock Box=S/L



Allen Wrench Box=AW/L

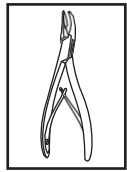

**61-4096-001**  
 Bracket Holding  
 Tweezers,  
 Scraper End



**61-4096-002**  
 Bracket Holding  
 Tweezers,  
 Round

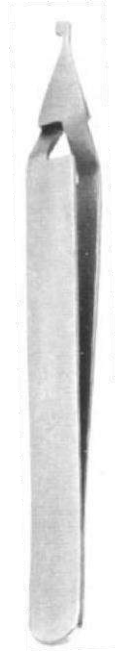

**61-4096-003**  
 Bracket Holding  
 Tweezers,  
 Round End



**61-4096-004**  
 Bracket Holding  
 Tweezers,  
 with Bracket Aligner



**61-4096-005**  
 Bracket Holding  
 Tweezers,  
 Curved



**61-4096-006**  
 Bracket Holding  
 Tweezers,  
 45 degree



**61-4096-007**  
 Bracket Holding  
 Tweezers,  
 90 degree



**61-4096-008**  
 Buccal Tube  
 Tweezers



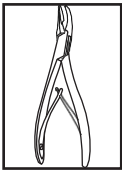

**Orthodontic Pliers**  
**Pinces d'atelier**  
**Zahntechnische Zangen**



**61-4088-TC**  
 Direct Bond Attachment  
 Removing Plier-Angled



**61-4089-TC**  
 Direct Bond Bracket Attachment  
 Removing Plier-Straight



**61-4090-TC**  
 Direct Bond Bracket Attachment  
 Removing Plier-Straight



**61-4091-TC**  
 Direct Bond Attachment  
 Removing Plier-Angled



**61-4092-TC**  
 Bond Removing Plier



**61-4093-000**  
 DBS Bracket Removing Plier



**61-4094-000**  
 Ligature Typing Plier  
 -Coon Type(Safety Type)



**61-4095-000**  
 Ligature Typing Plier



**61-4096-000**  
 Mathieu Type

**BOX SELECTION**



Box Lock=B/L



Screw Lock Box=S/L



Allen Wrench Box=AW/L

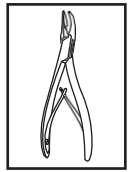

**61-4097-000**  
 Elastic Placing Plier



**61-4098-000**  
 Ligating Plier



**61-4099-000**  
 Ligature Utility Plier

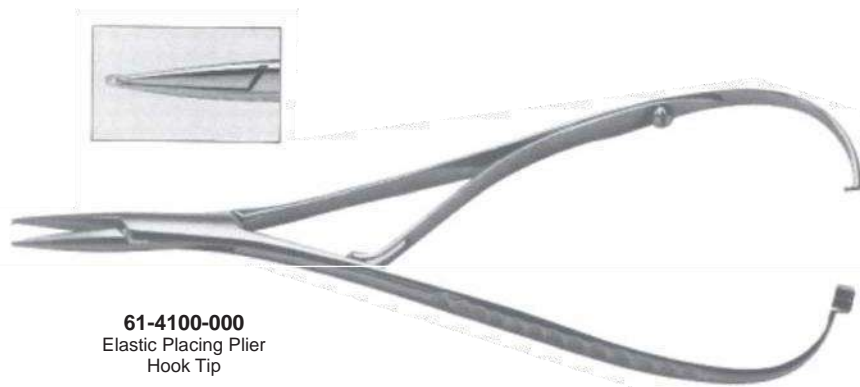

**61-4100-000**  
 Elastic Placing Plier  
 Hook Tip



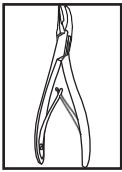

**Orthodontic Pliers**  
**Pinces d'atelier**  
**Zahntechnische Zangen**



**61-4101-000**  
 Mosquito  
 Forceps  
 Curved

**61-4102-000**  
 Mosquito Forceps-Straight



**61-4103-000**  
 Ligature Director



**61-4104-000**  
 Ligature & Director



**61-4105-000**  
 Twister



**61-4106-000**  
 Ligature Director-Single End



**61-4106-001**  
 Distal End Bender/Twister, .22" (.56mm)

**61-4106-002**  
 .30" (.76mm)



**61-4107-000**  
 Band Contouring Plier



**61-4108-000**  
 DE LA Rosa Plier



**61-4109-000**  
 Crown Contouring Plier



**61-4110-000**  
 Crown Crimping Plier



**61-4111-000**  
 Crown Crimping  
 Plier-Slim

**BOX SELECTION**



Box Lock=B/L



Screw Lock Box=S/L



Allen Wrench Box=AW/L

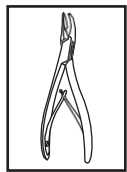

**61-4112-TC**  
 Posterior Band Removing  
 Plier



**61-4113-TC**  
 Posterior Band Removing  
 Plier



**61-4114-TC**  
 Posterior Band Removing  
 Plier-Long



**61-4115-000**  
 Posterior Band Removing  
 Plier



**61-4116-TC**  
 Posterior Band Removing  
 Plier-Long



**61-4117-TC**  
 Posterior Band Removing  
 Plier



**61-4118-000**  
 Anterior Band Removing  
 Plier



**61-4121-000**  
 Ki-Type Bar  
 Bending Pliers  
 Type # 2



**61-4119-000**  
 Big Young Plier  
 Bending Plier

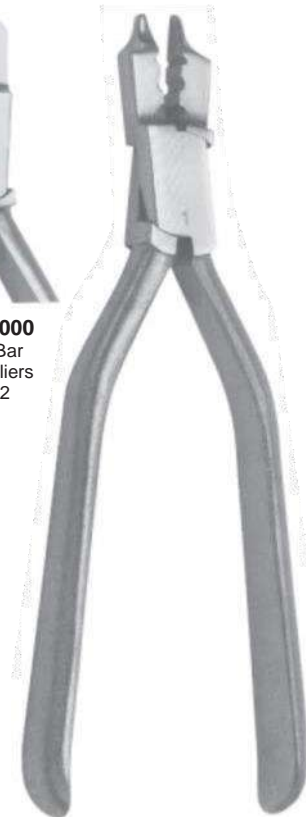

**61-4120-000**  
 Ki-Type Bar Bending Pliers  
 Type # 1



**BOX SELECTION**



Box Lock=B/L



Screw Lock Box=S/L



Allen Wrench Box=AW/L

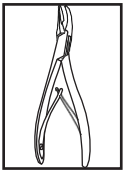

**Orthodontic Pliers**  
**Pinces d'atelier**  
**Zahntechnische Zangen**



**61-4125-000**  
 Direct Bond Bracket



**61-4126-000**  
 Wire Bending Plier



**61-4130-TC**  
 Wire Twister 6"  
 with Carb-N-Sert Jaws



**61-4131-TC**  
 Wire Twister 8"  
 with Carb-N-Sert Jaws

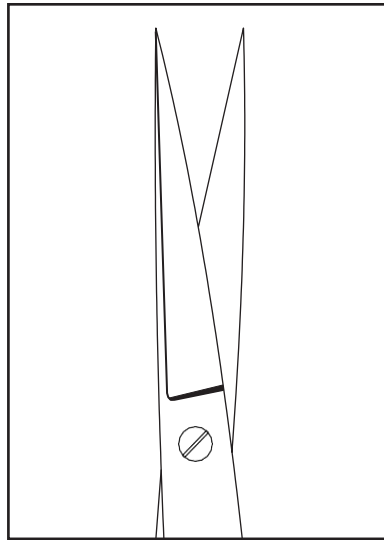

**Operating Scissors**  
**Ciseaux chirurgicaux**  
**Chirurgische Scheren**



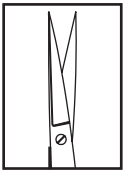

**Operating Scissors**  
**Ciseaux chirurgicaux**  
**Chirurgische Scheren**

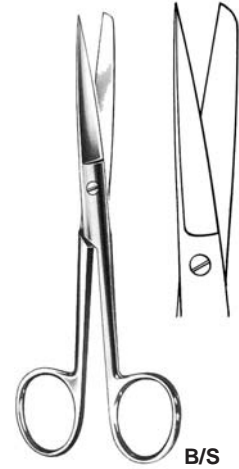
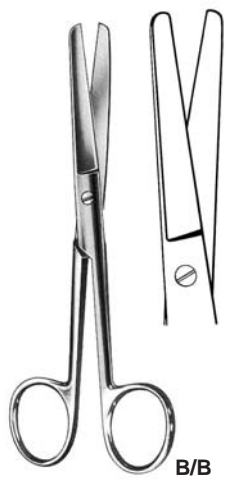

Cm	Inch			
13	5"	62-010-130	62-014-130	62-012-130
14.5	5¾"	62-010-145	62-014-145	62-012-145
15	6"	62-010-150	62-014-150	62-012-150
16.5	6½"	62-010-165	62-014-165	62-012-165
17.5	7"	62-010-175	62-014-175	62-012-175

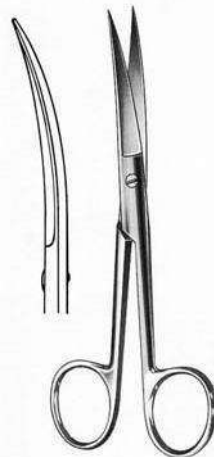

Cm	Inch			
13	5"	62-021-130	62-017-130	62-019-130
14.5	5¾"	62-021-145	62-017-145	62-019-145
15	6"	62-021-150	62-017-150	62-019-150
16.5	6½"	62-021-165	62-017-165	62-019-165
17.5	7"	62-021-175	62-017-175	62-019-175

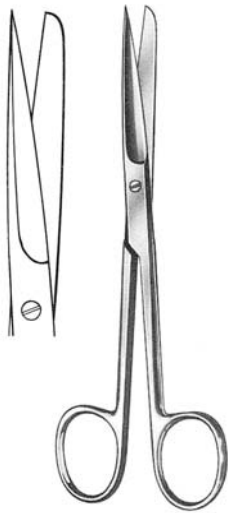
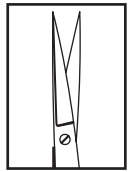

**Deaver**  
14cm / 5½"  
62-036-140

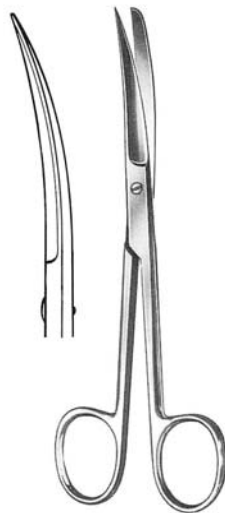

**Deaver**  
14cm / 5½"  
62-041-140

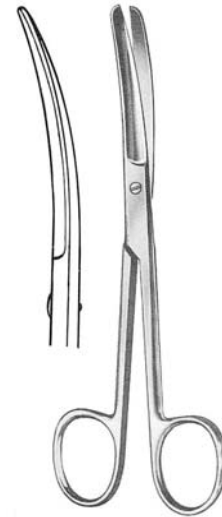

**Deaver**  
14cm / 5½"  
62-039-140

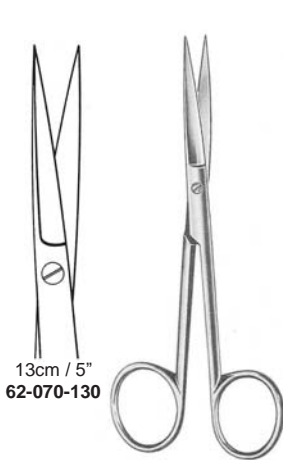

13cm / 5"  
62-070-130



14.5cm / 5¾"  
62-070-145

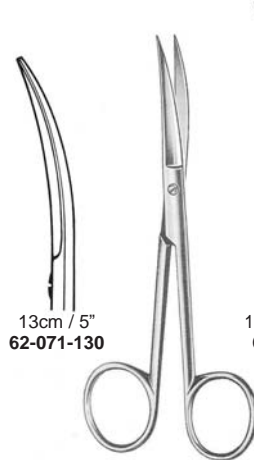

13cm / 5"  
62-071-130



14.5cm / 5¾"  
62-071-145

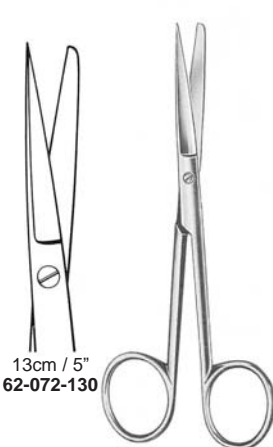

13cm / 5"  
62-072-130

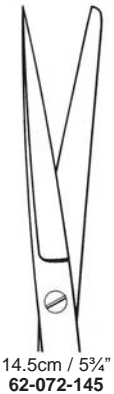

14.5cm / 5¾"  
62-072-145

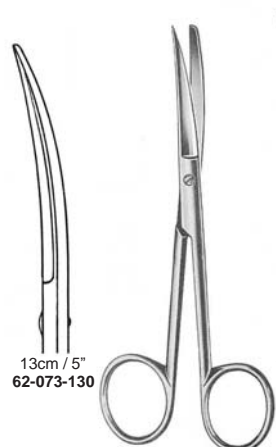

13cm / 5"  
62-073-130



14.5cm / 5¾"  
62-073-145



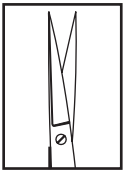

**Delicate Scissors**  
Ciseaux délicats  
Feine Scheren

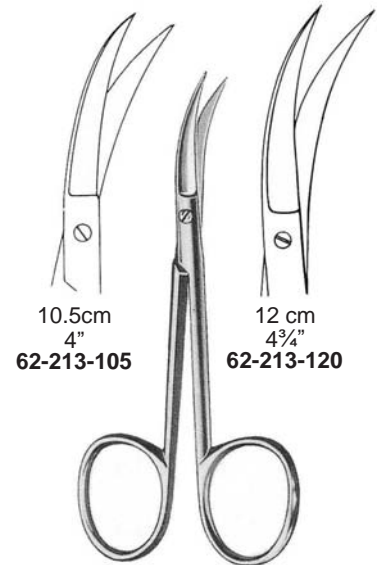
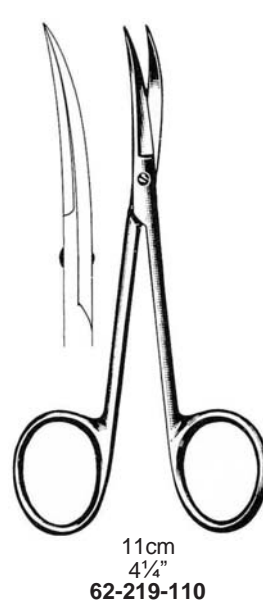
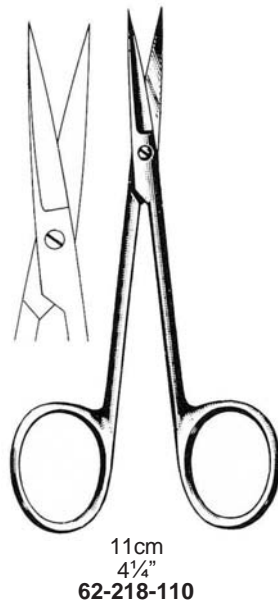
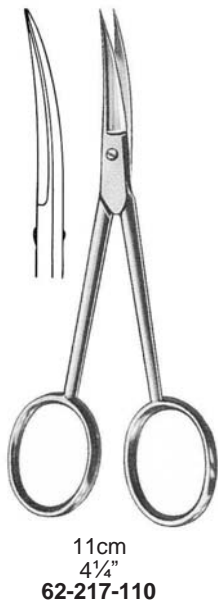
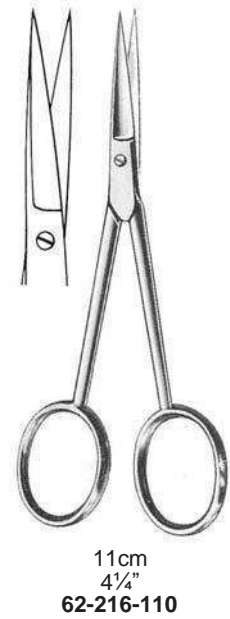
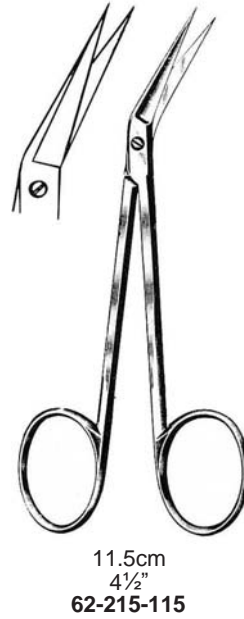
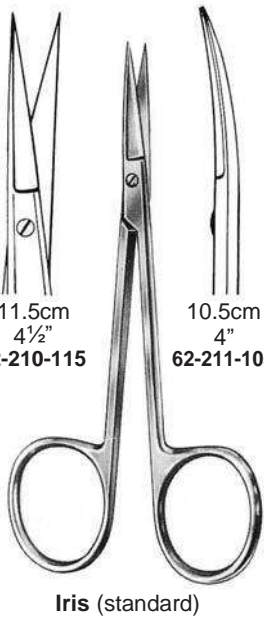
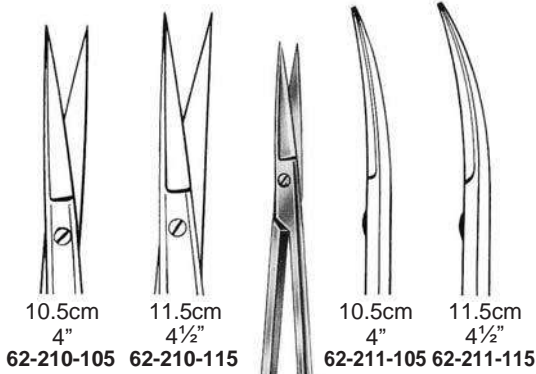

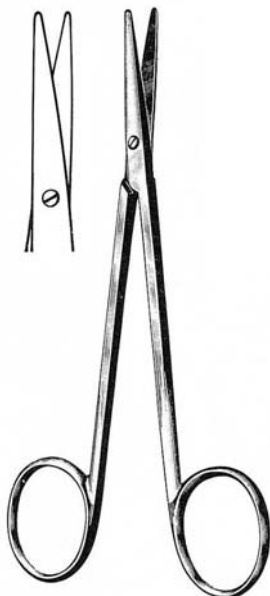

12 cm  
4 3/4"  
**62-230-120**

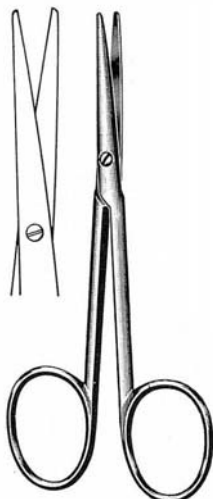

**LEXER-BABY**  
10 cm  
4"  
**62-056-100**

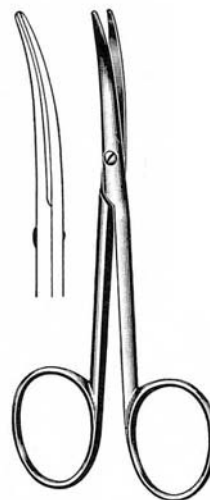

**LEXER-BABY**  
10 cm  
4"  
**62-057-100**

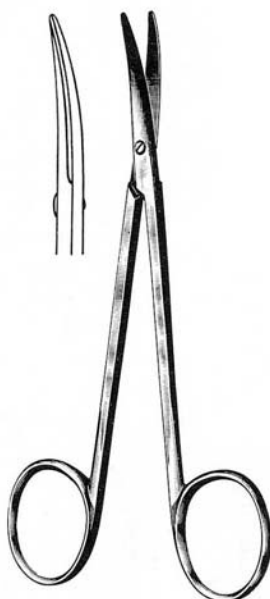

12 cm  
4 3/4"  
**62-231-120**

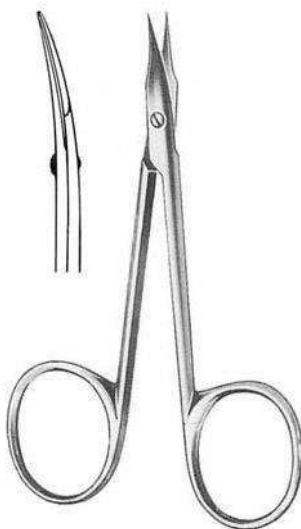

10 cm  
4"  
**62-223-100**

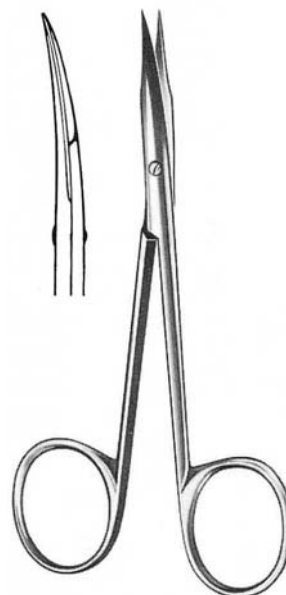

12.5 cm  
5"  
**62-223-125**



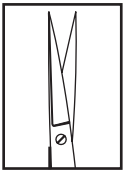

**Operating and Dissecting Scissors**  
**Ciseaux à opérations et à préparatio**  
**Präparierscheren**

**SMITH**

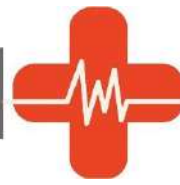

**SONS**

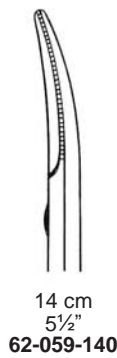
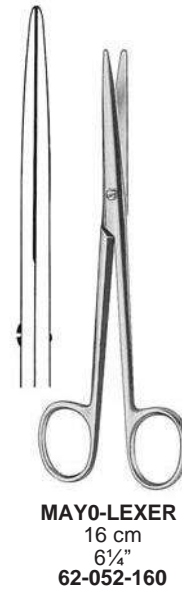
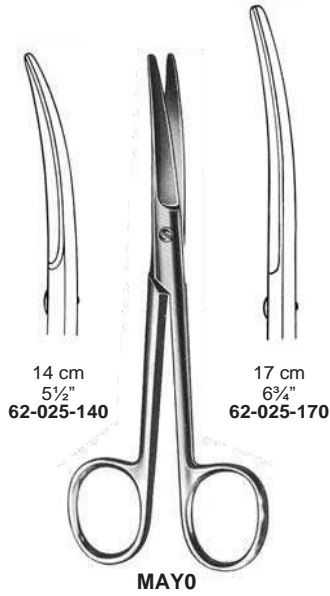
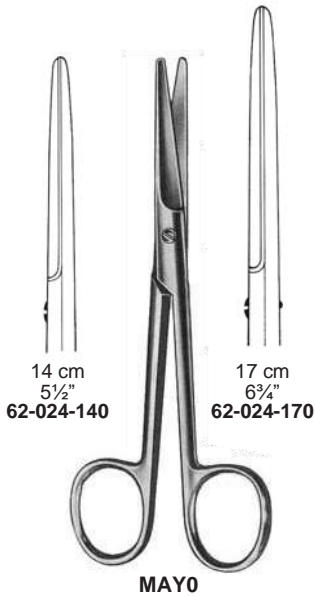

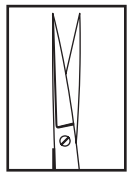

**Metzenbaum**  
18 cm  
7"  
62-054-180



**Metzenbaum**  
18 cm  
7"  
62-057-180

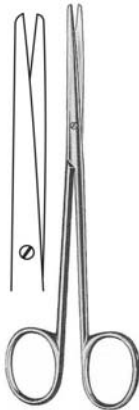

**Metzenbaum (Delicate)**  
14 cm  
5½"  
62-048-140



**Metzenbaum (Delicate)**  
14 cm  
5½"  
62-051-140



**Metzenbaum (Delicate)**  
18 cm  
7"  
62-048-180



**Metzenbaum (Delicate)**  
18 cm  
7"  
62-051-180

**Gum Scissors**  
Ciseaux à gencives  
Zahnfleischscheren



14 cm  
5½"  
62-410-140



**Brophy**



14 cm  
5½"  
62-411-140



14 cm  
5½"  
62-412-140



**Brophy (Slim)**



14 cm  
5½"  
62-413-140



14 cm  
5½"  
62-416-140



**Sanvenero**



14 cm  
5½"  
62-417-140

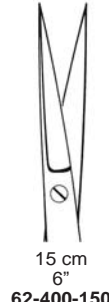

15 cm  
6"  
62-400-150



**Joseph**



15 cm  
6"  
62-401-150



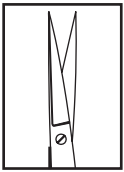

**Gum Scissors**  
Ciseaux à gencives  
Zahnfleischscheren

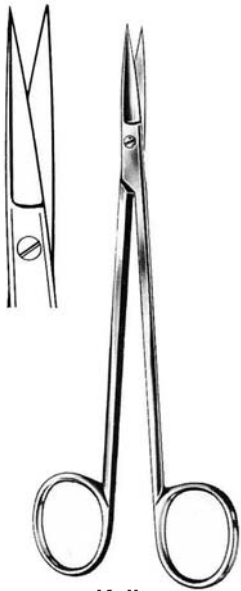

**Kelly**  
16 cm  
6 1/4"  
62-600-160

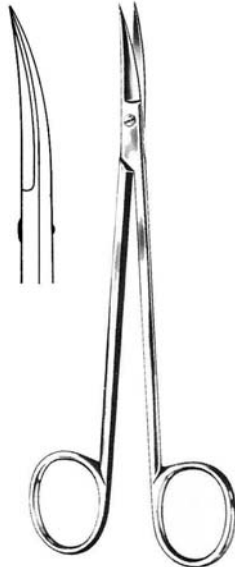

**Kelly**  
16 cm  
6 1/4"  
62-601-160

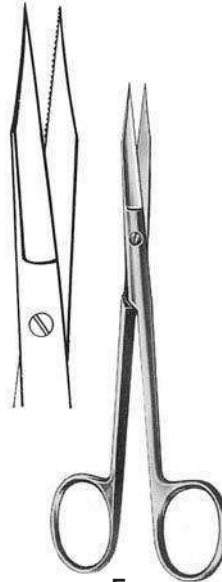

**Fox**  
13 cm  
5"  
62-260-130

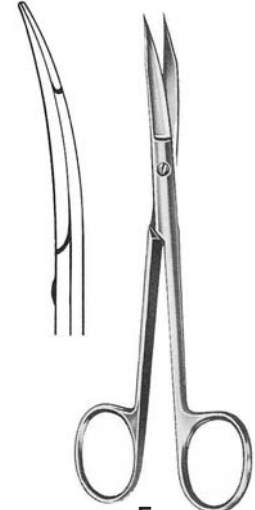

**Fox**  
13 cm  
5"  
62-261-130

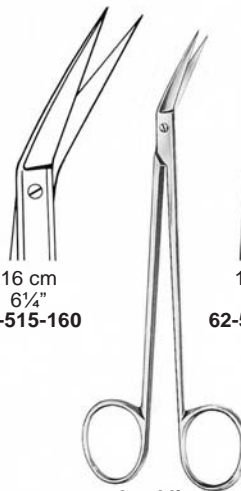

**Locklin**



**Serrated**  
dentelé  
gezahnt

16 cm  
6 1/4"  
62-517-160



**Serrated**  
dentelé  
gezahnt

16 cm  
6 1/4"  
62-519-160



16 cm  
6 1/4"  
62-521-160

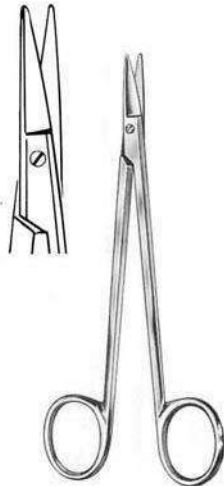

**Quinby**  
13 cm  
5"  
62-250-130

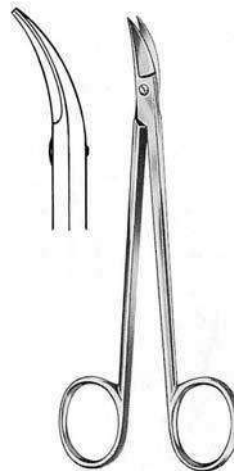

**Quinby**  
13 cm  
5"  
62-251-130

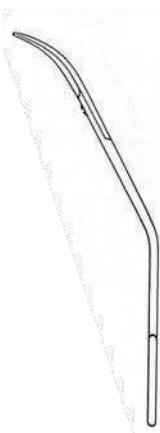
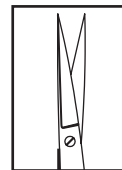

**Niro**  
14 cm  
5½"  
62-523-140



**La Grange**  
14 cm  
5½"  
62-525-140



**La Grange**  
10.5 cm  
5"



62-527-105 62-529-105  
Serrated  
dentelé  
gezahnt

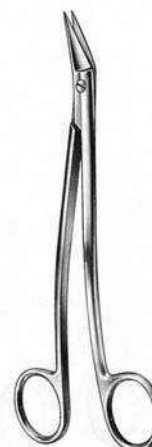

**Dean**  
17 cm  
6¾"  
62-443-170

**Super Cut Scissors**  
Super Cut Ciseaux  
Super Cut Scheren

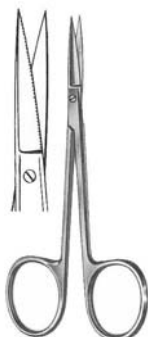

**Iris Standard**  
11.5 cm  
4½"  
62-216-115



**Iris Standard**  
11.5 cm  
4½"  
62-217-115



**Fox**  
13 cm  
5"  
62-229-130

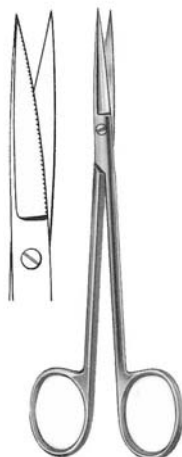

**Joseph**  
15 cm  
6"  
62-402-150



**Joseph**  
15 cm  
6"  
62-403-150

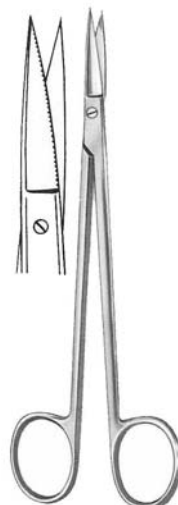

**Kelly**  
16 cm  
6¼"  
62-602-160

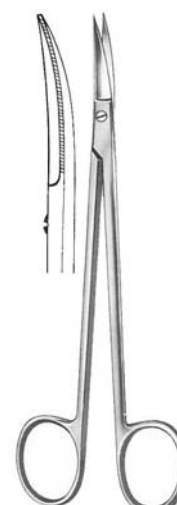

**Kelly**  
16 cm  
6¼"  
62-603-160



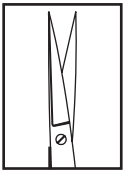

**Stitch Scissors**  
Ciseaux à ligatures  
Fadenscheren

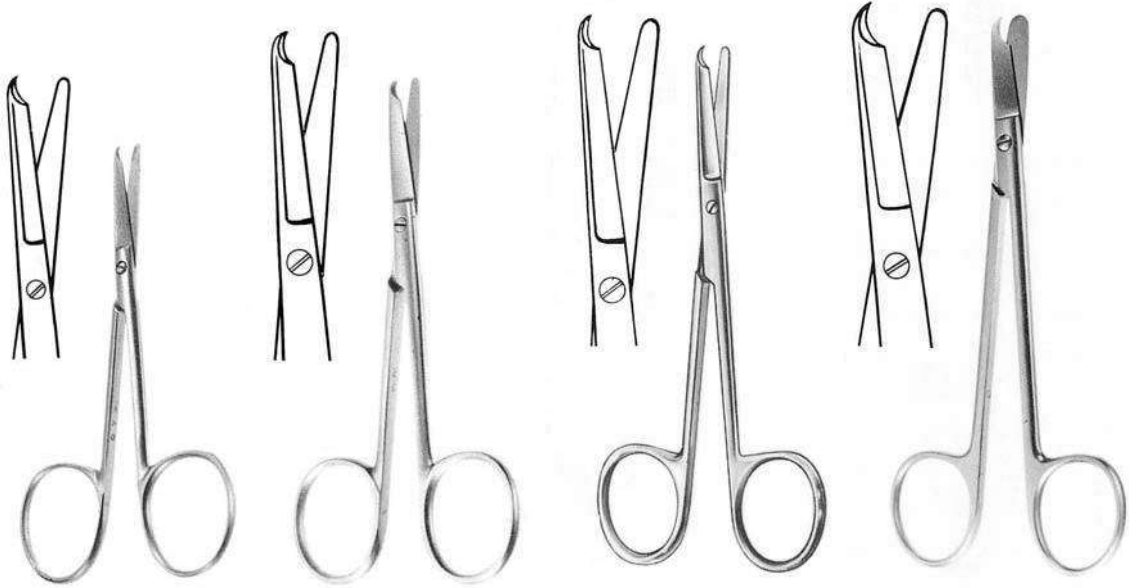

**Spencer**  
9 cm  
3½"  
62-680-090

**Spencer**  
10.5 cm  
4"  
62-680-105

**Spencer**  
12 cm  
4½"  
62-680-120

**Littauer**  
13 cm  
5"  
62-684-130



**Kelly Stitch**  
15 cm  
6"  
62-686-150

**Spencer**  
11.5 cm  
4½"  
62-687-115

**Spencer (Northbent)**  
12 cm  
4½"  
62-689-120

**Locklin**  
15 cm  
6"  
62-691-150

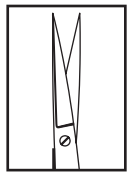

Sharp  
Pointer  
Spitz



**Beebee**  
10.5 cm  
4"

Serrated  
dentelé  
gezahnt

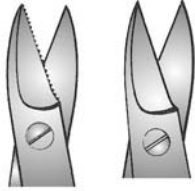

62-672-105 62-670-105

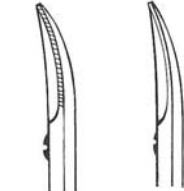

62-673-105 62-671-105

Blunt  
Mousse  
Stumpf



**Beebee**  
10.5 cm  
4"

Serrated  
dentelé  
gezahnt

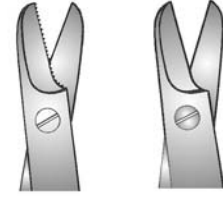

62-676-105 62-674-105

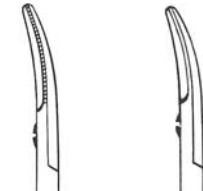

62-677-105 62-675-105

Sharp  
Pointer  
Spitz



**Bee bee**  
12.5 cm  
5"

Serrated  
dentelé  
gezahnt

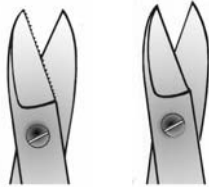

62-672-125 62-670-125

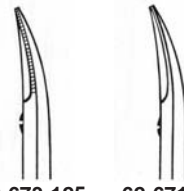

62-673-125 62-671-125

Blunt  
Mousse  
Stumpf



**Bee bee**  
12.5 cm  
5"

Serrated  
dentelé  
gezahnt

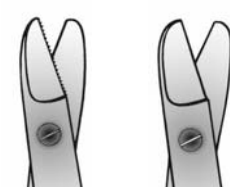

62-676-125 62-674-125

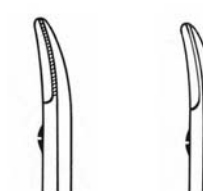

62-677-125 62-675-125



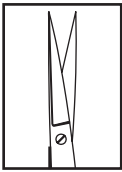

**Wire Cutting Scissors, serrated**  
**Ciseaux coupe-fil, dentelés**  
**Draht-und Blehscheren, gezahnt**

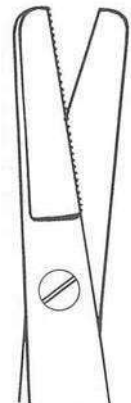
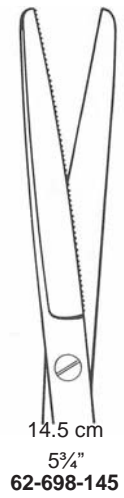
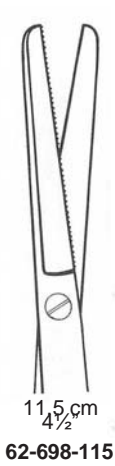

Serrated  
dentelé  
gezahnt

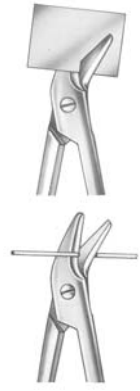
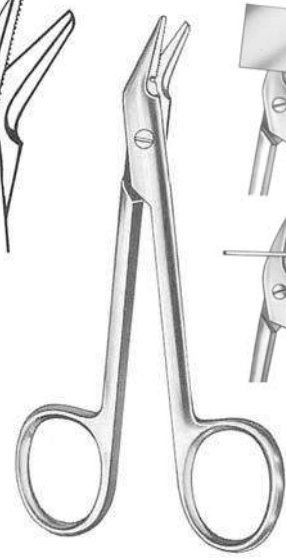
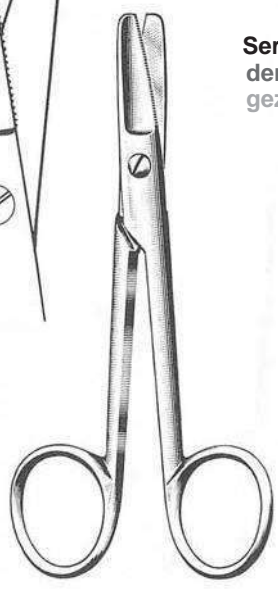
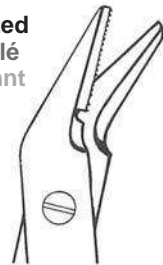

**Bandage Scissors**  
**Ciseaux à pansements**  
**Verbandscheren**

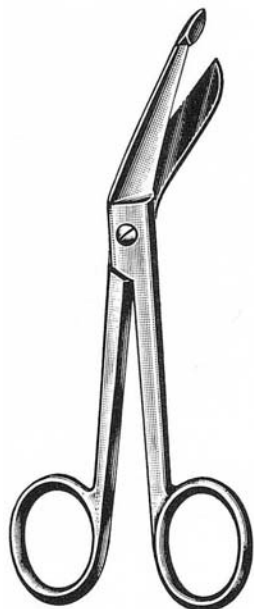

18 cm  
7"  
62-709-180

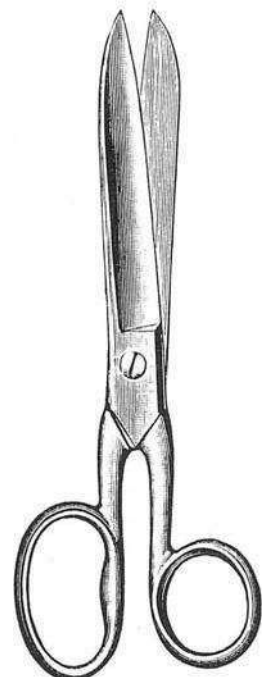
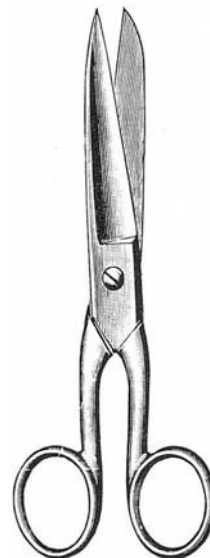

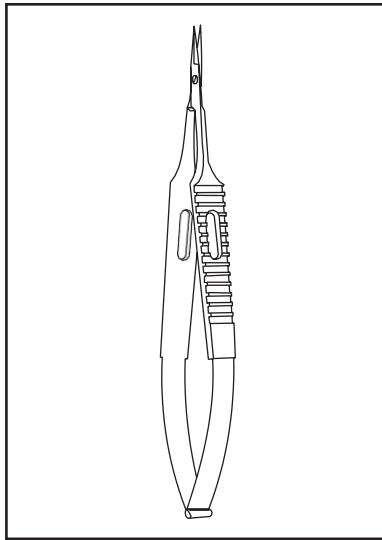

**Micro Scissors**  
**Micro-Ciseaux**  
**Mikro-Scheren**



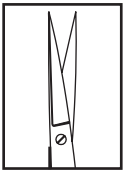

**Micro Scissors**  
 Micro - Ciseaux  
 Mikro - Scheren



Serrated  
 dentelé  
 gezahnt

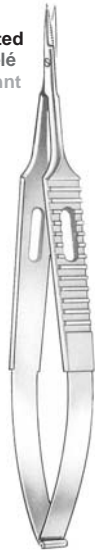

12.5 cm  
 5"  
 63-020-125

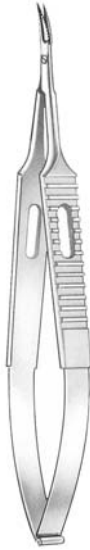

12.5 cm  
 5"  
 63-023-125

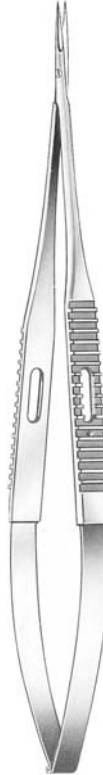

18 cm  
 7"  
 63-026-180

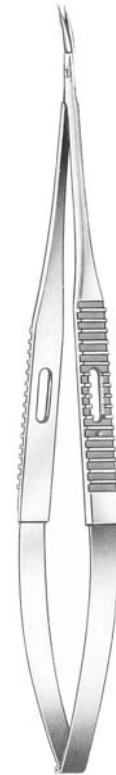

18 cm  
 7"  
 63-027-180



**Castroviejo**  
 11 cm  
 4 1/2"  
 63-101-110



**Noyes**  
 11 cm  
 4 1/2"  
 63-041-110

Blunt  
 Mousse  
 Stumpf



**Westcott**  
 11 cm  
 4 1/2"  
 63-123-110



Sharp  
 Pointer  
 Spitz

**Westcott**  
 11 cm  
 4 1/2"  
 63-121-110

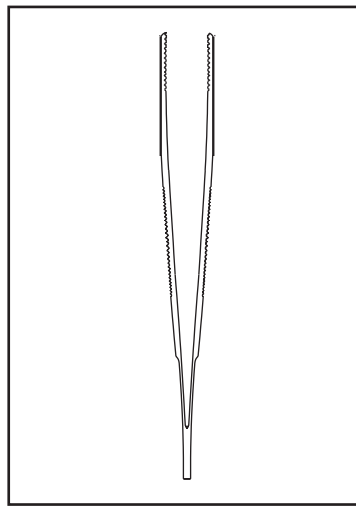

**Dressing Forceps**  
**Pinces anatomiques**  
**Anatomische Pinzetten**



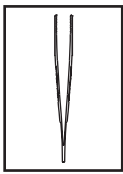

**Dressing Forceps**  
**Pinces anatomiques**  
**Anatomische Pinzetten**



Cm	Inch				
13	5"	64-010-130	64-012-130	64-011-130	64-013-130
14.5	5¾"	64-010-145	64-012-145	64-011-145	64-013-145
16	6¼"			64-011-160	64-013-160
18	7"	64-010-180	64-012-180	64-011-180	64-013-180
25	10"	64-010-250	64-012-250		

**Tissue Forceps**  
**Pinces chirurgicales**  
**Chirurgische**

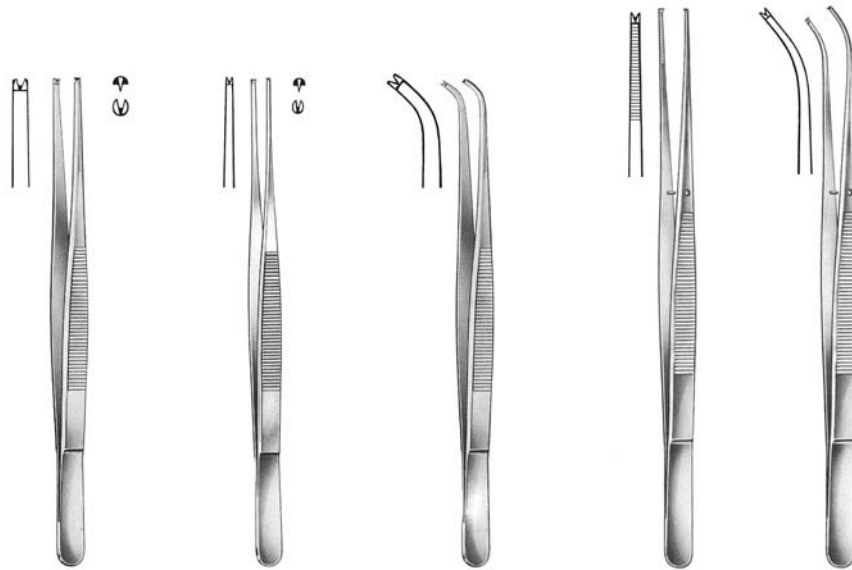

Cm	Inch	Standard		Potts-Smith	Brophy
13	5"	64-191-130	64-161-130	64-173-130	
14.5	5¾"	64-191-145	64-161-145	64-173-145	
16	6¼"			64-173-160	
18	7"	64-191-180	64-161-180		64-339-180
20	8"	64-191-200	64-161-200		64-339-200 64-349-200
25	10"	64-191-250	64-161-250		64-339-250



**Adson**  
12 cm  
4¾"  
64-050-120



**Adson**  
12 cm  
4¾"  
64-273-120



**Micro-Adson**  
15 cm  
6"  
64-052-150



**Micro-Adson**  
15 cm  
6"  
64-280-150



**Semken**  
12.5 cm  
5"  
64-098-125



**Semken**  
15 cm  
6"  
64-098-150



**Semken**  
12.5 cm  
5"  
64-099-125



**Semken**  
15 cm  
6"  
64-099-150



**Cm**    **Inch**  
11    4½"    64-042-110



13    5"    64-042-130



64-175-110

64-175-130



64-177-150

64-177-180

64-177-200

15    6"    64-044-150

18    7"    64-044-180

20    8"    64-044-200



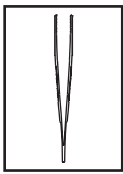

**Delicate Forceps**  
Pincès délicates  
Feine Pinzetten

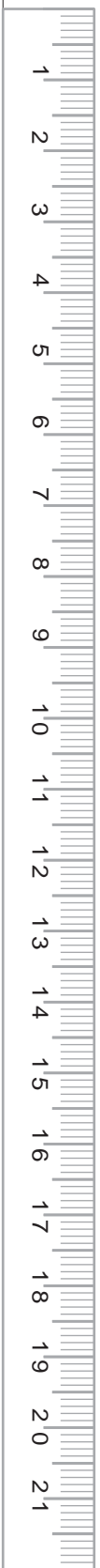

**McIndoe**  
15 cm  
6"  
64-092-150

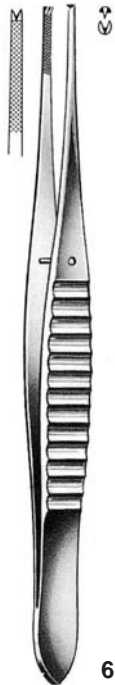

**Gillies**  
15 cm  
6"  
64-259-150



15 cm  
6"  
64-124-150



20 cm  
8"  
64-124-200



15 cm  
6"  
64-351-150



20 cm  
8"  
64-351-200

**Splinter Forceps**  
Pincès à échardes  
Splitterpinzetten



Cm	Inch		
10.5	4"	64-422-105	64-425-105
11.5	4½"	64-422-115	64-425-115



**Gum and Tissue Forceps**  
Pincès pour saisir les gencives  
Zahnfleisch- und Gewebezängchen



Cm	Inch				
13	5"	64-427-130	64-429-130	64-431-130	
15	6"	64-427-150	64-429-150		64-435-150



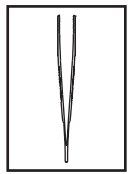

**Suture Forceps**  
Pince à suture  
Nahtpinzette

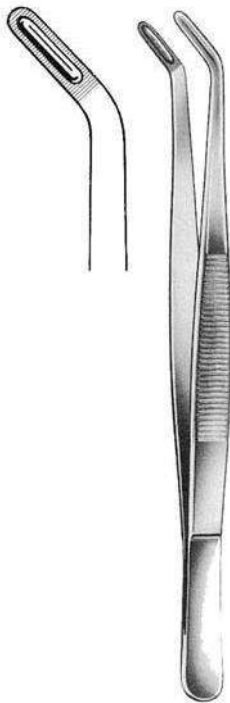

**Allen**  
18 cm  
7"  
64-463-180

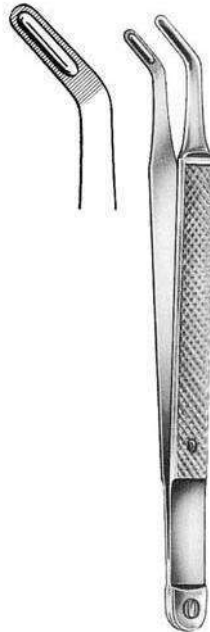

**Albrecht**  
16 cm  
6 1/4"  
64-465-160

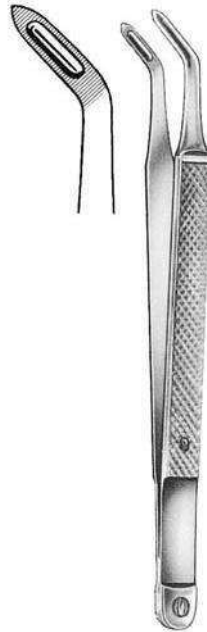

**Albrecht**  
16 cm  
6 1/4"  
64-467-160



15 cm  
6"  
64-469-150

**Dental Pliers**  
Brucelles  
Zahnpinzetten

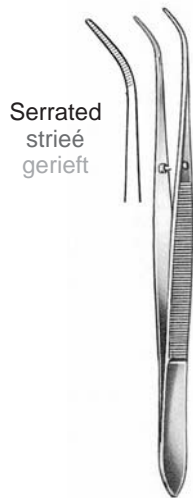

Serrated  
strieé  
gerieft

**Perry**  
13 cm  
5"  
64-471-130



Smooth  
lisse  
glatt

**Perry**  
13 cm  
5"  
64-475-130

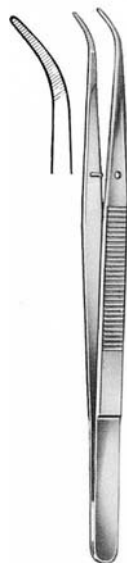

**London College**  
15 cm  
6"  
64-477-150



Smooth  
lisse  
glatt

**London College**  
15 cm  
6"  
64-479-150

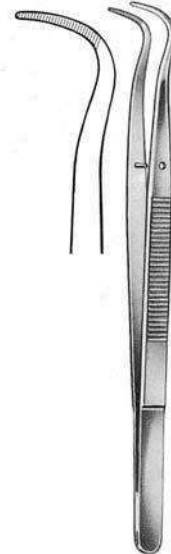

**London College**  
15 cm  
6"  
64-481-150



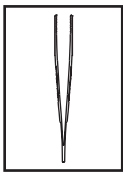

Dental Pliers  
Brucelles  
Zahnpinzetten



64-483-150  
Serrated



London College  
15 cm  
6"

64-485-150  
Smooth

64-487-150  
Serrated  
Delicte



London College  
15 cm  
6"

64-489-150  
Smooth  
Delicate



London College  
15 cm  
6"  
64-491-150



London College  
15 cm  
6"  
64-493-150

with Lock  
avec cremaillère  
mit schloß

64-495-160  
Serrated



Meriam  
16 cm  
6 1/4"

64-497-160  
Smooth

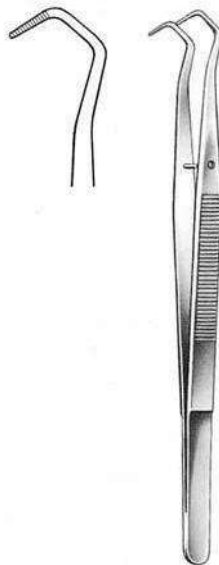

College  
14.5 cm  
5 3/4"  
64-703-145

64-705-160  
Serrated



Flagg  
16 cm  
6 1/4"

64-707-160  
Smooth

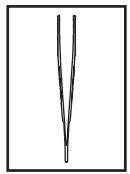

64-709-150



**Landgraf**  
15 cm  
6"



64-711-150



15.5 cm  
6 1/8"  
64-713-155

root pin pliers  
pincés a pivots  
wurzelstiftpinzetten



15.5 cm  
6 1/8"  
64-715-155

**Dental Pliers For Nerve Needle**  
Brucelles tire-nerfs  
Nervnadelpinzetten



15 cm  
6"  
64-717-150



15.5 cm  
6 1/8"  
64-719-155



16.5 cm  
6 1/2"  
64-721-165



15.5 cm  
6 1/8"  
64-723-155



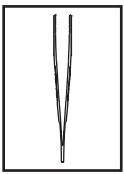

**Dental Pocket Markers**  
**Pinces pour culs-de-sac**  
**Zahntaschenpinzetten**

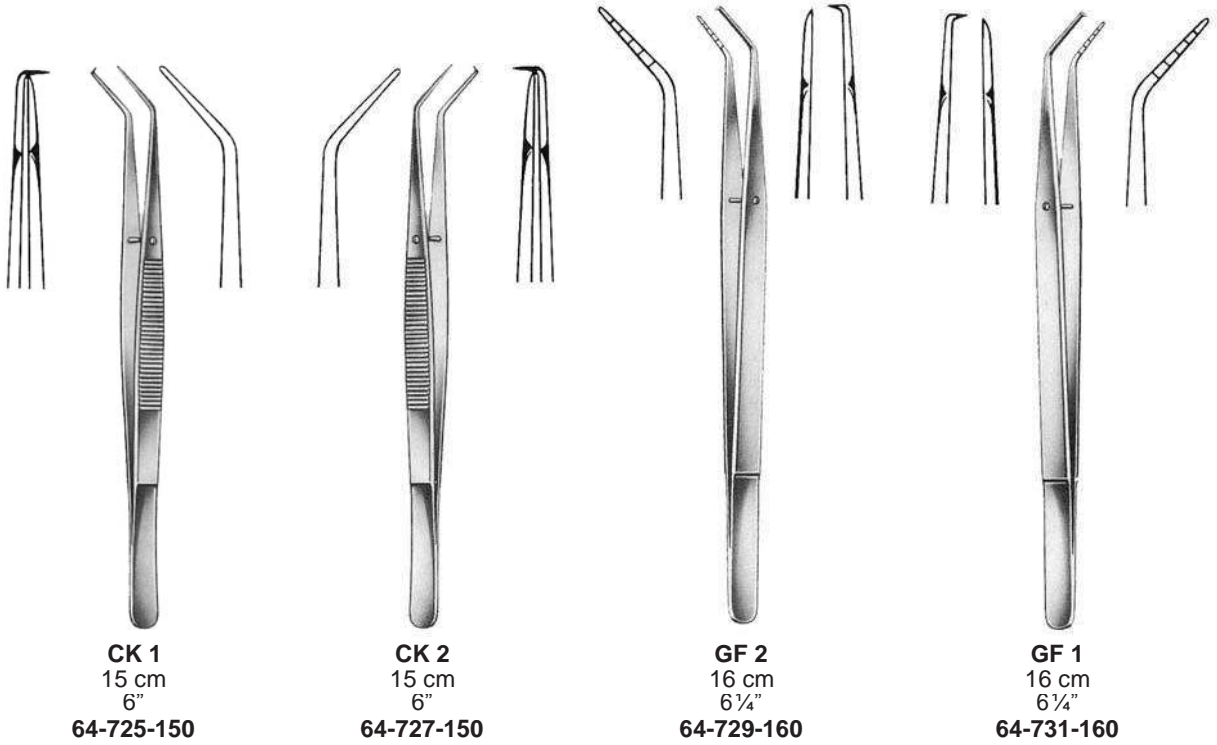
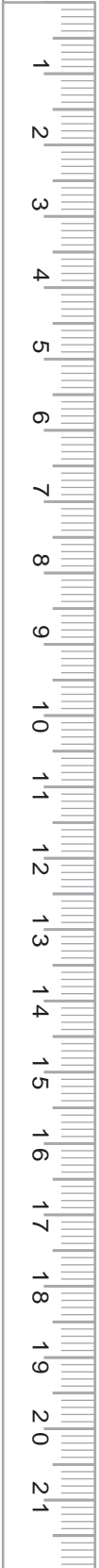

**Soldering Tweezers**  
**Brucelles à souder**  
**Lötpinzetten**

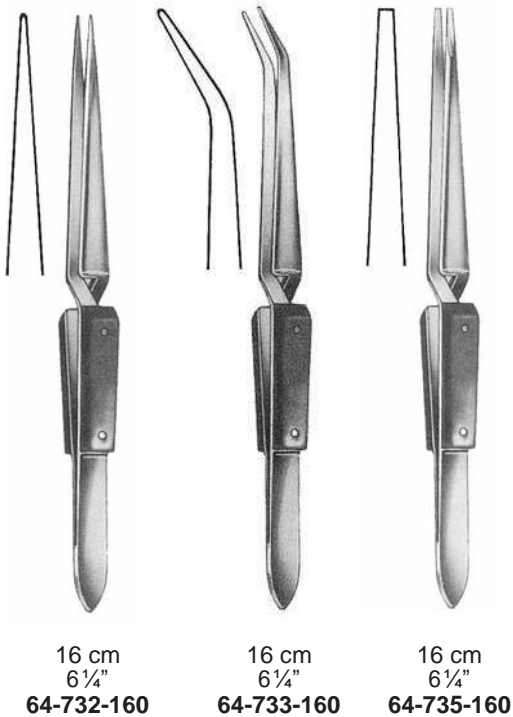

**Articulation Paper Forceps**  
**Pince pour papier à articler**  
**Artikulationspapier-Pinzette**

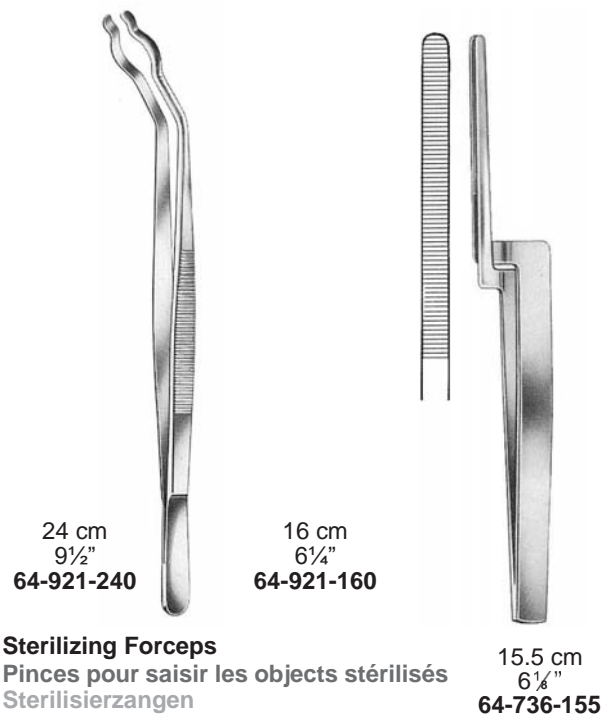

**Sterilizing Forceps**  
**Pinces pour saisir les objets stérilisés**  
**Sterilisierzangen**

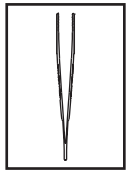

Tomatti  
64-435-012



Ochsenbein  
64-417-010



Ochsenbein  
64-417-011



Gardner  
64-417-001



Gardner  
64-417-002



Gardner  
64-417-003



Gardner  
64-417-004



Gardner  
64-417-005



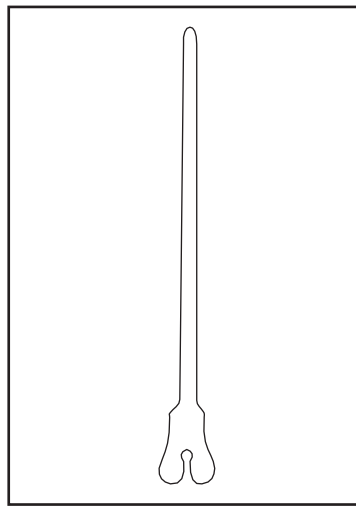

**Probes**  
**Stylets boutonnés**  
**Knopfsonden**



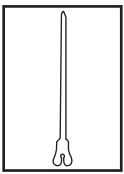

**Probes**  
**Stylets boutonnés**  
**Knopfsonden**

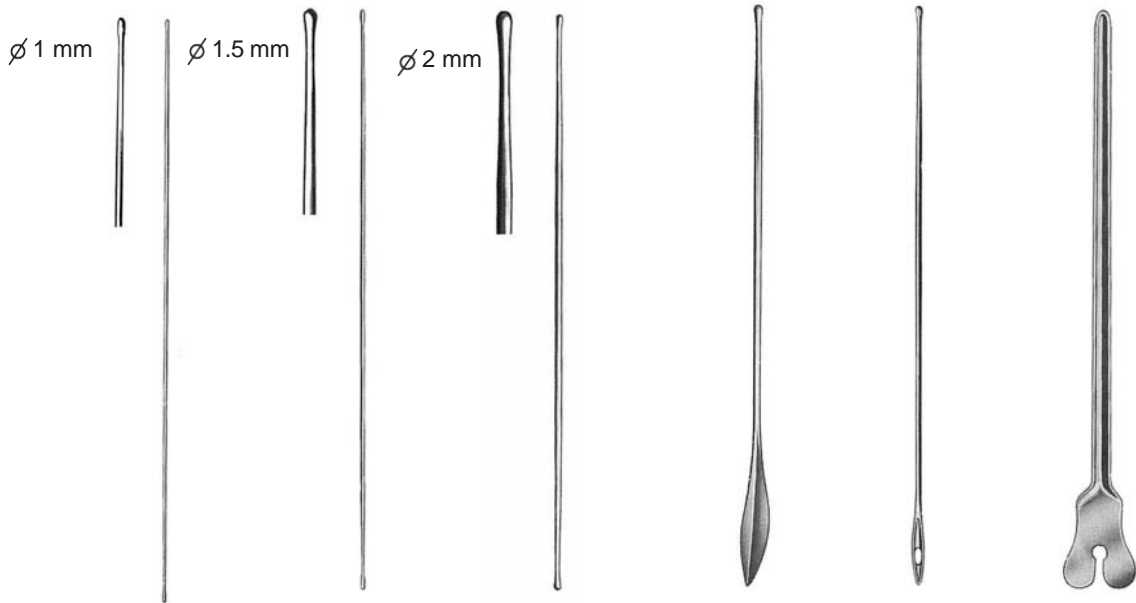

Cm	Inch						
13	5 1/8"		65-030-130	65-040-130	65-070-130	65-050-130	65-080-130
14.5	5 3/4"	65-028-145	65-030-145	65-040-145	65-070-145	65-050-145	65-080-145
16	6 1/4"		65-030-160	65-040-160	65-070-160	65-050-160	65-080-160

**Cotton Carriers**  
**Porte-coton**  
**Watteträger**

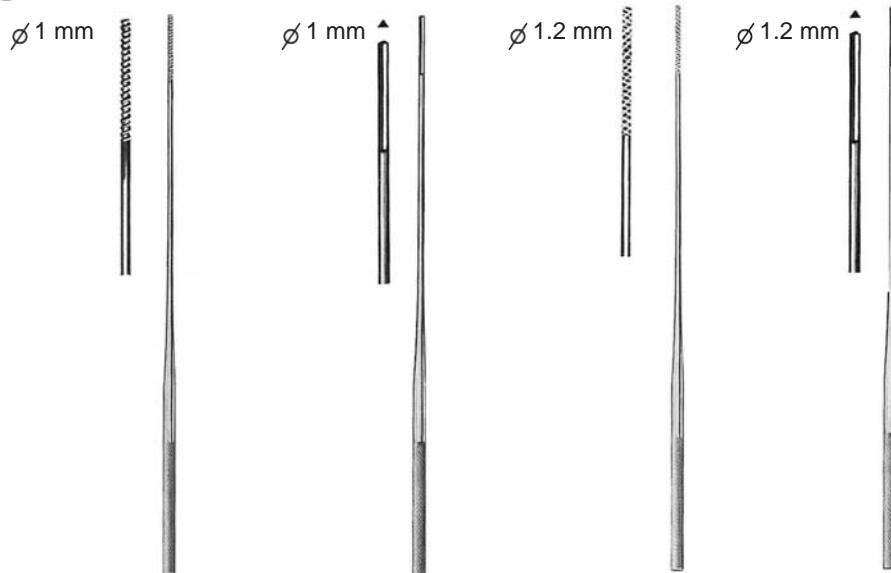

Cm	Inch				
12	4 3/4"	65-230-120	65-240-120	65-250-120	65-260-120
14	5 1/2"	65-230-140	65-240-140	65-250-140	65-260-140
16	6 1/4"	65-230-160	65-240-160	65-250-160	65-260-160

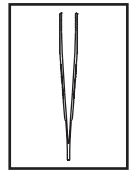

0-10 mm

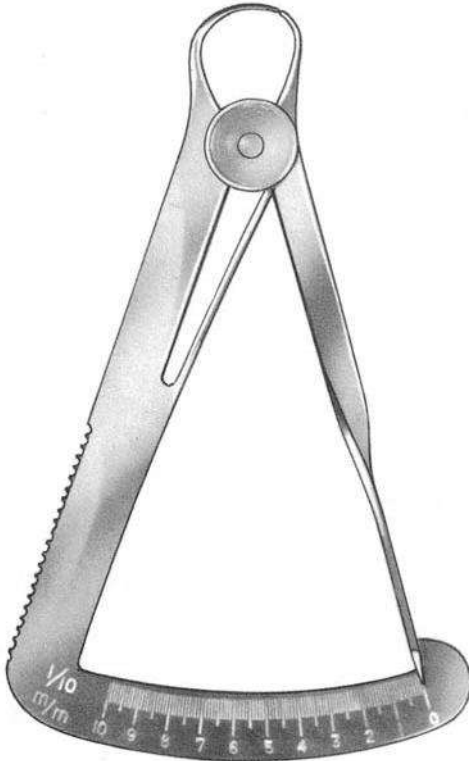

**Iwanson**  
 Double Side Marking  
 Metal : 65-310-010  
 Wax: 65-310-011

0-100 mm

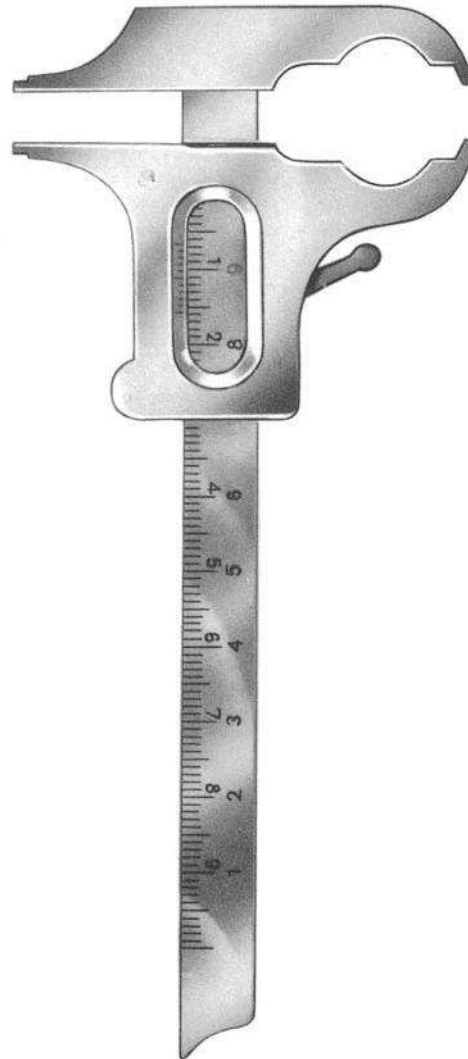

**Boley**  
 65-320-100



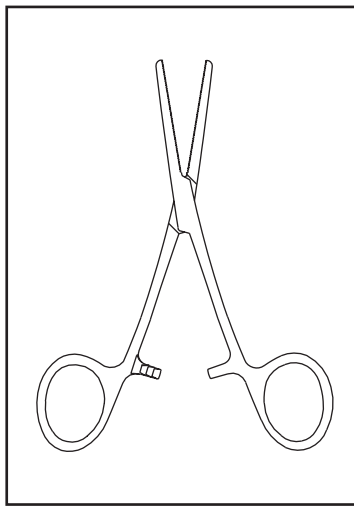

**Artery Forceps**  
**Pinces hémostatiques**  
**Arterienklemmen**



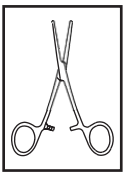

**Artery Forceps**  
Pincés hémostatiques  
Arterienklemmen

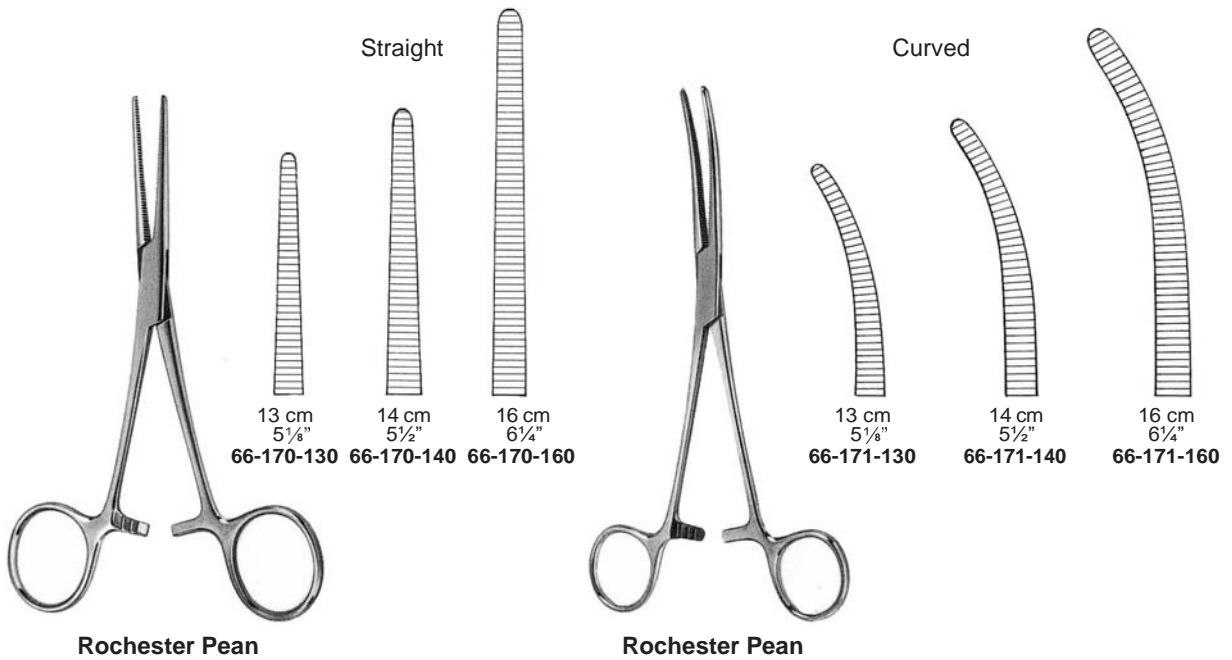
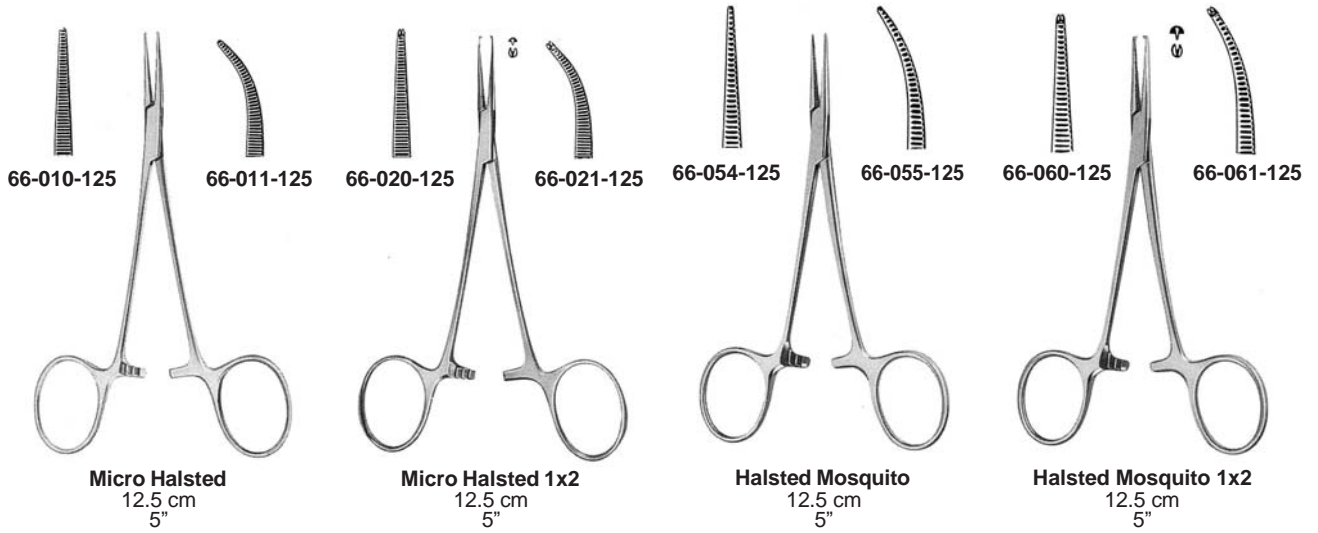

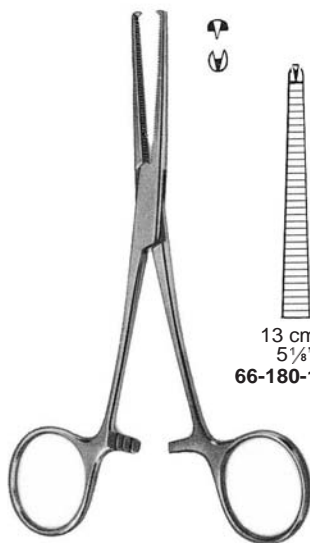
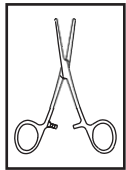

**Kocher**  
 Straight

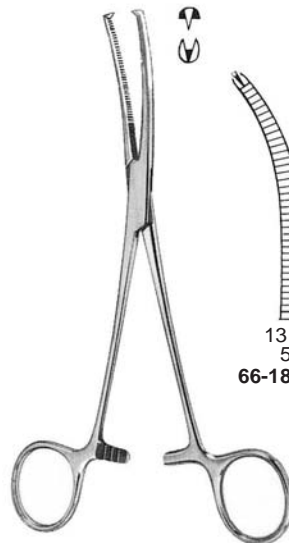
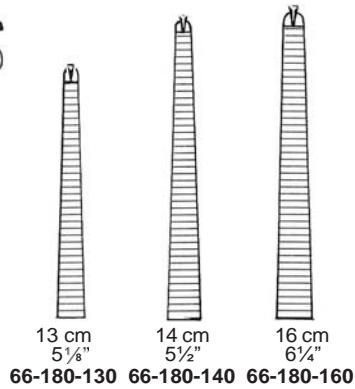

**Kocher**  
 Curved

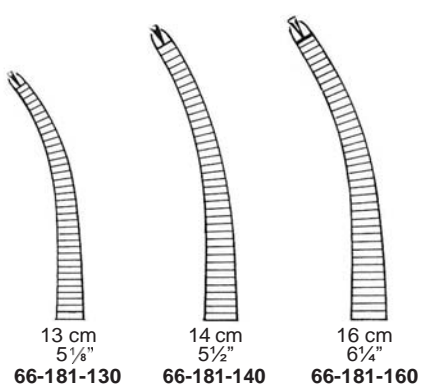

66-070-140  
STR.

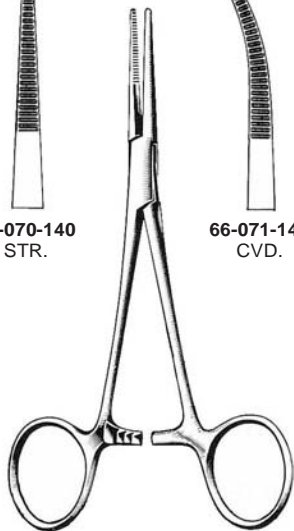

**Kelly**  
 14 cm  
 5 1/2"



66-071-140  
CVD.



66-082-140  
STR.

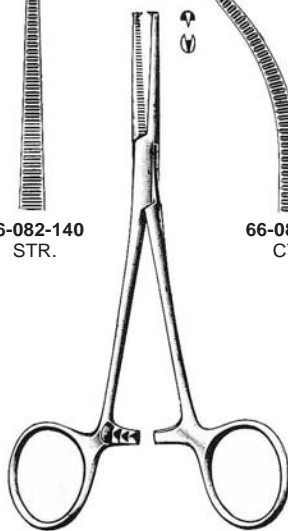

**Crile Kocher**  
 14 cm  
 5 1/2"



66-083-140  
CVD.

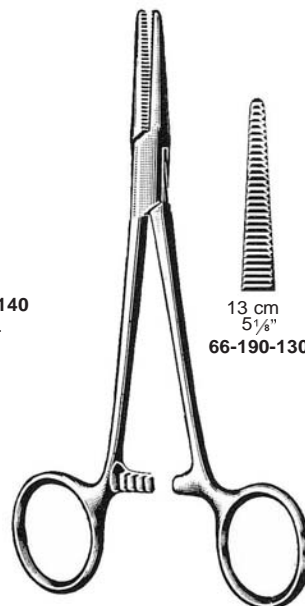

**Spencer Wells**  
 Straight



66-190-130  
13 cm  
5 1/8"



66-190-140  
14 cm  
5 1/2"



66-190-160  
16 cm  
6 1/4"



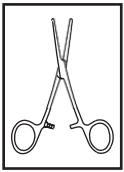

**Artery Forceps**  
Pincers hémostatiques  
Arterienklemmen



**Gum and Tissue Forceps**  
Pincers pour saisir les gencives  
Zahnfleisch- und Gewebezängchen

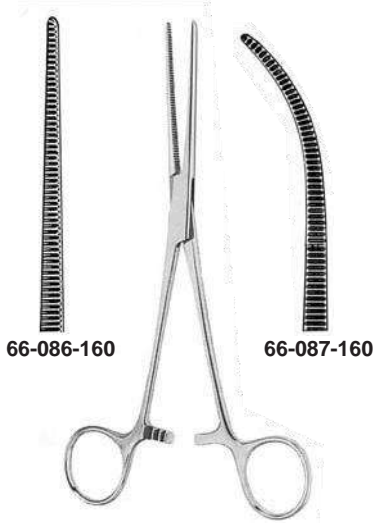

66-086-160

66-087-160

**Pean-Dixon**  
16 cm  
6 1/4"

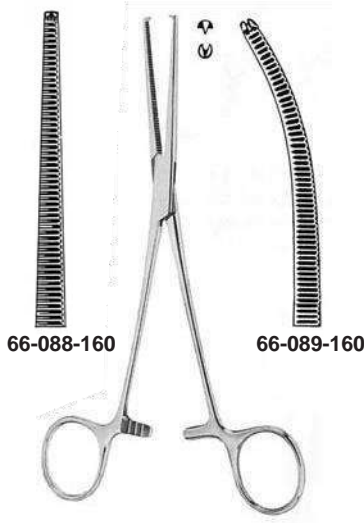

66-088-160

66-089-160

**Ochsner-Dixon**  
16 cm  
6 1/4"



**Allis**  
15 cm  
6"  
66-620-150



**Allis-Niro**  
15 cm  
6"  
66-641-150

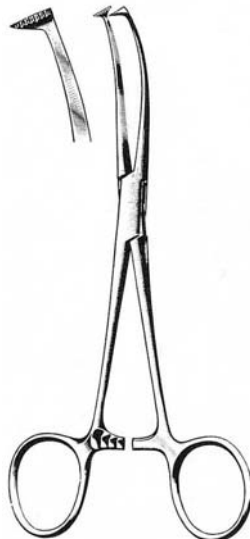

**Fox**  
15.5 cm  
6 1/8"  
66-643-155

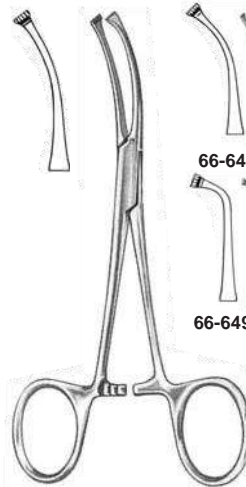

**Allison-Baby**  
13 cm  
5 1/8"  
66-645-130

66-647-130

66-649-130



**Allison-Baby**  
13 cm 14 cm  
5 1/8" 5 1/2"  
66-650-130 66-650-140

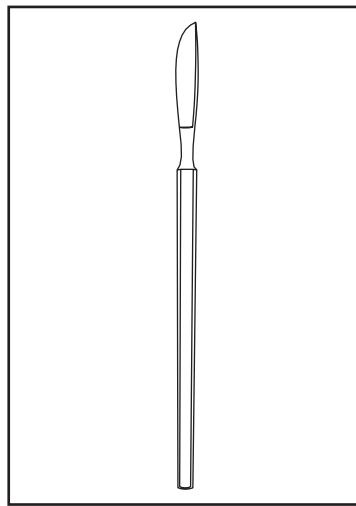

**Operating Knives**  
**Bistouris à opération**  
**Zahnfleischmesser**



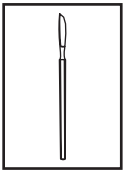

**Scalpel Handles**  
Manches pour Bistouris  
Skalpellgriffe



No. 3  
68-010-030  
68-010-033  
with scale

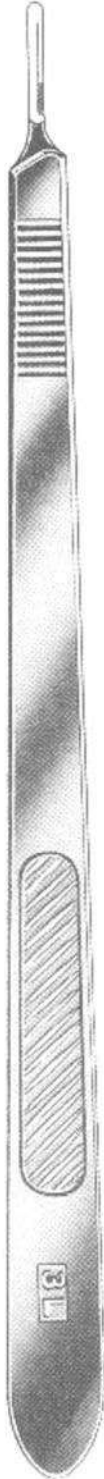

No. 3 L  
68-010-031



No. 4  
68-014-040



No. 4 L  
68-014-041



No. 7  
68-010-070

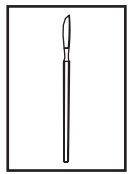

**Dieffenbach**



1/1  
Fig 1  
**68-050-001**



1/1  
Fig 2  
**68-050-002**



1/1  
Fig 3  
**68-050-003**



1/1  
Fig 4  
**68-050-004**



1/1  
Fig 5  
**68-050-005**



1/1  
Fig 6  
**68-050-006**



1/1  
Fig 7  
**68-050-007**



1/1  
Fig 8  
**68-050-008**



1/1  
Fig 9  
**68-050-009**



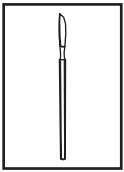

**Abscess Knives**  
Bistouris à abcès  
Abszeßmesser



68-136-001



68-136-002



68-136-003



68-136-004

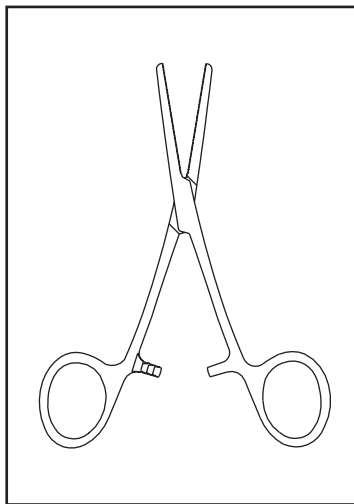

**Needle Holders**  
**Porte-aiguilles**  
**Nadelhalter**



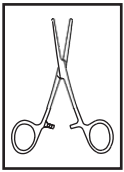

**Needle Holders**  
 Porte-aiguilles  
 Nadelhalter



**Collier**  
 13 cm  
 5 1/8"  
 69-174-130



**Webster**  
 12.5 cm  
 5"  
 69-148-125



**Wright (Derf)**  
 12.5 cm  
 5"  
 69-324-125



**Halsey**  
 13.5 cm  
 5 1/2"  
 69-172-135



**Baumgartner**  
 14 cm  
 5 1/2"  
 69-158-140



**Baby Crile-Wood**  
 15 cm  
 6"  
 69-138-150



**Crile-Wood**  
 15 cm  
 6"  
 69-140-150

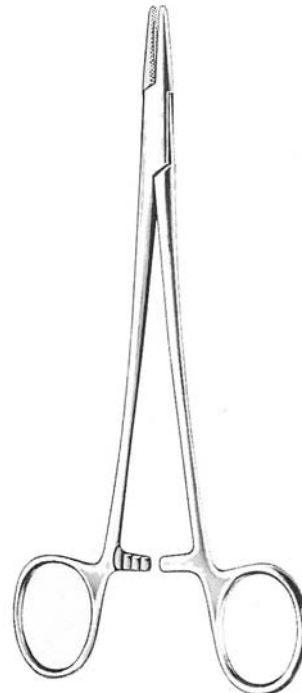

**Mayo-Hegar**

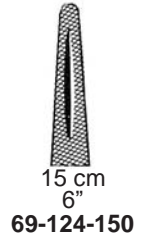

15 cm  
 6"  
 69-124-150

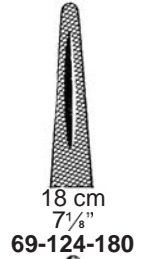

18 cm  
 7 1/4"  
 69-124-180

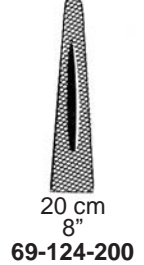

20 cm  
 8"  
 69-124-200

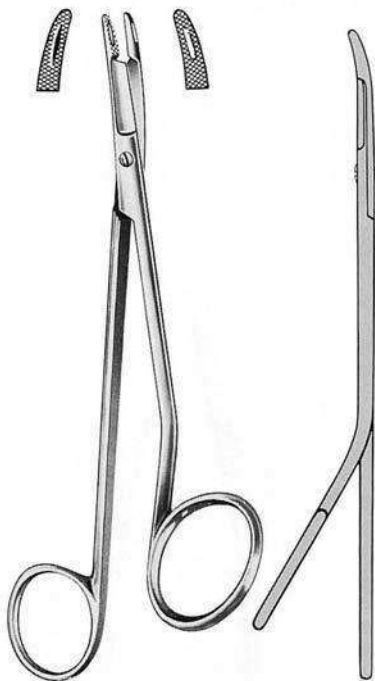
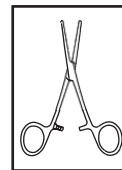

**Gillies-slim**  
 14.5 cm  
 5 3/4"  
 69-149-145

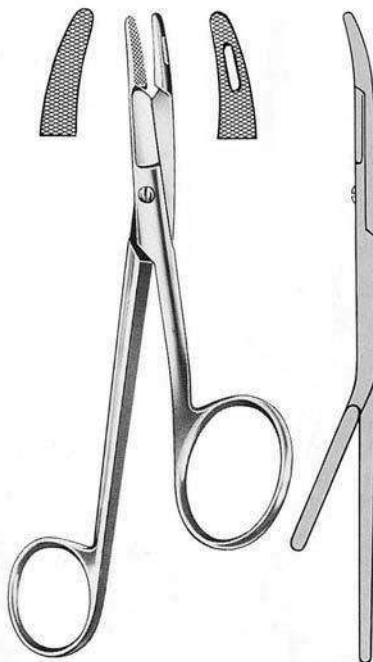

**Gillies**  
 15.5 cm  
 6"  
 69-151-155



**Olsen-Hegar**  
 14 cm 17 cm  
 5 1/2" 6 3/4"  
 69-150-140 69-150-170



**Mathieu-Kocher**

14 cm  
 5 1/2"  
 69-212-140

17 cm  
 6 3/4"  
 69-212-170

20 cm  
 8"  
 69-212-200

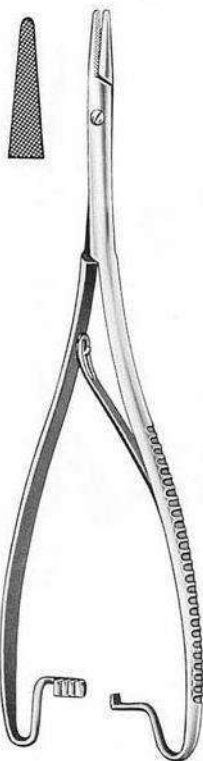

20 cm  
 8"  
 69-214-200



**Langenbeck**

16 cm  
 6 1/4"  
 69-230-160

18 cm  
 7 1/4"  
 69-230-180

20 cm  
 8"  
 69-230-200



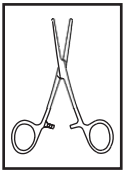

**Needle Holders**  
Porte-aiguilles  
Nadelhalter



**Crile**  
15 cm  
6"  
69-220-150

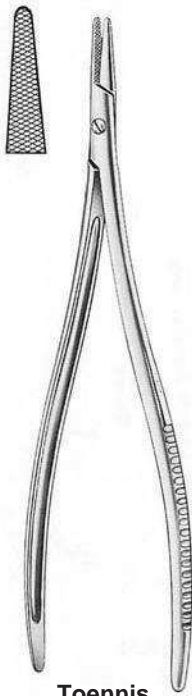

**Toennis**  
18 cm  
7 1/8"  
69-178-180

**Micro Needle Holders**  
Micro-Porte-aiguilles  
Mikro-Nadelhalter

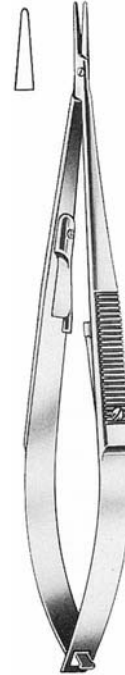

**Castroviejo**  
14 cm      17 cm  
5 1/2"      6 3/4"  
69-350-140      69-350-170

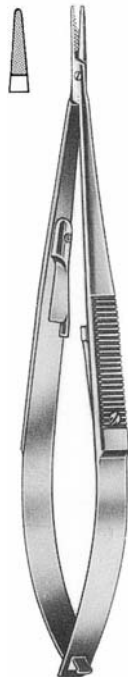

**Castroviejo**  
14 cm      17 cm  
5 1/2"      6 3/4"  
69-352-140      69-352-170



**Boynton**  
12 cm  
4 3/4"  
69-270-120



**Articulators**  
**Artikulatoren**  
**Articuladores**





**Articulators**  
**Artikulatoren**  
**Articuladores**



70-3410-000  
 Professional Articulator



70-3411-000  
 Average Articulator  
 with Magnets



70-3412-000  
 Anatomical Articulator



70-3413-000  
 UNI Magnetic Articulator



70-3414-000  
 Vibrated Finished



70-3415-000  
 Galett Articulator  
 Color Coated



70-3416-000  
 Professional Articulator



70-3417-000  
 Adjustable Articulator



70-3418-000  
 Full Denture Articulator



70-3419-00  
 Full Aren Articulator



70-3420-00  
 Full Denture Articulator

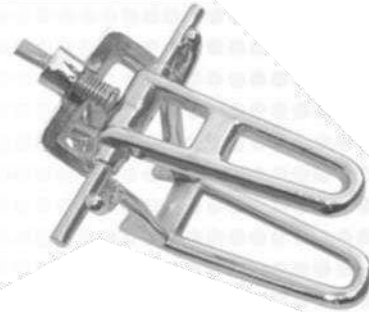

70-3420-00  
 Crown & Bridge Articulator

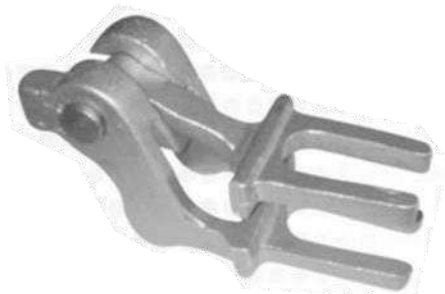

70-3423-00  
 Denture Articulator Brass Made



70-3424-00  
 Denture Articulator

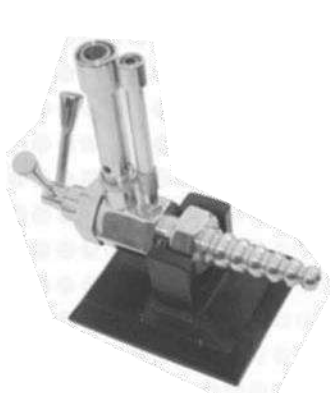

70-3426-00  
 Lab Burner D/E



70-3427-00  
 Lab Burner D/E



70-3428-00  
 Dental Flasks Press





**Articulators**  
**Artikulatoren**  
**Articuladores**



70-3401-000



70-3402-000



70-3403-000



70-3404-000  
Occlusor

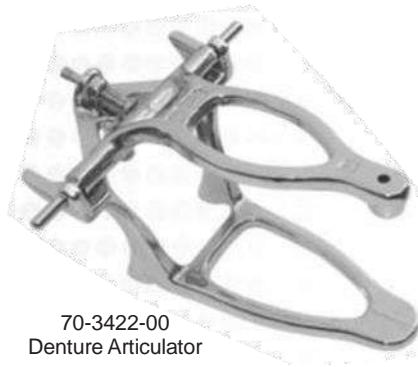

70-3422-00  
Denture Articulator



70-3425-00  
Full Denture Articulator Flat



70-3406-000



70-3407-000



70-3500-00  
Endodontic Bob

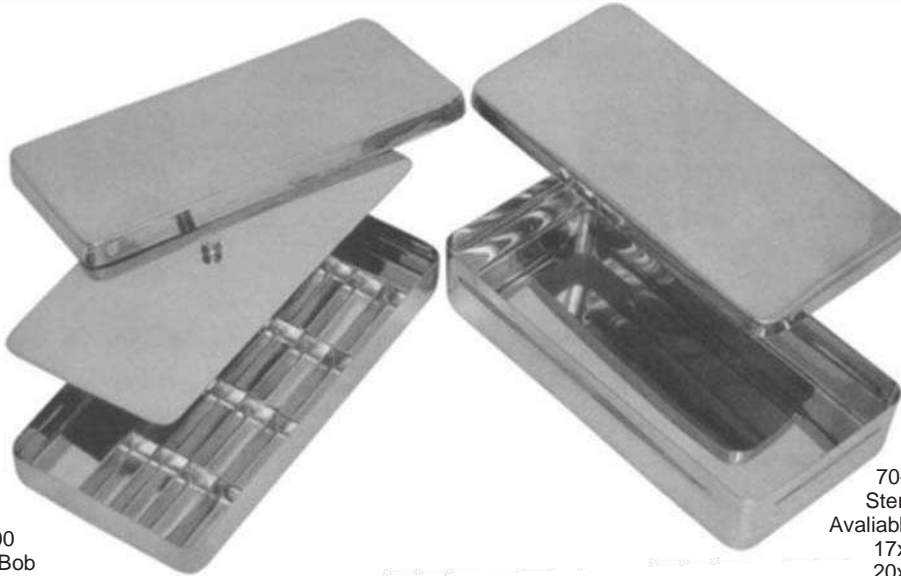

70-3501-00  
Sterilizing Box  
Avaliable in Dif. Sizes  
17x17x3 cm  
20x10x4 cm  
25x12x6 cm  
30x14x6 cm



70-3502-00  
Endo Tray Box

**STERLIZE BOX**



70-3505-00



70-3506-00



70-3507-00





**Hollowware**  
Hohlgas  
Hueco

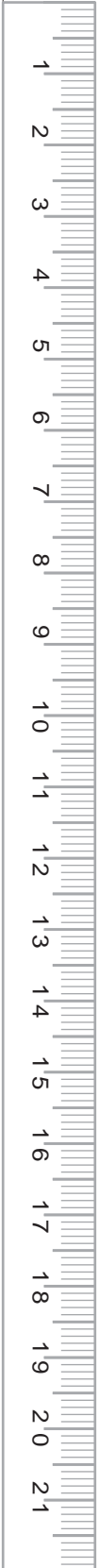

70-3508-000



70-3509-000



70-3510-000



70-3511-000



70-3512-000



70-3513-000



70-3520-00  
Forcep Jar



70-3514-000



70-3515-000



70-3503-00  
Cotton Dispenser



70-3516-000



70-3517-000



70-3518-000



70-3519-000



70-3521-00  
Gallipot with & without Lid



70-3504-00  
Alcohol Lamp



70-3522-00  
Spitting Mug

70-3523-00  
Spirit Lamp



70-3527-00  
Instruments Tray



70-3528-00  
Instruments Tray



70-3529-00  
Instruments Tray  
(Perforated)



70-3530-00  
Instruments Tray Shallow

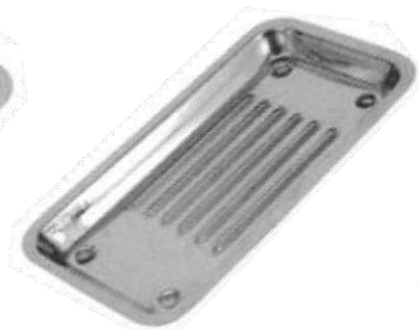

70-3531-00  
Scalers Tray



70-3532-00  
Cathetar Tray





**Hollowware**  
Hohlgas  
Hueco

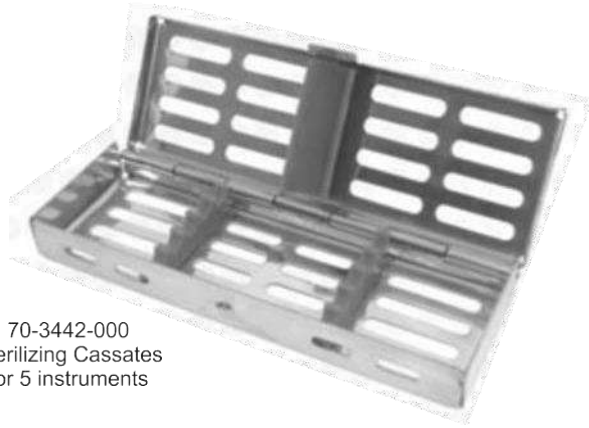

70-3442-00  
Sterilizing Cassetes  
for 5 instruments



70-3443-00  
Sterilizing Cassetes  
for 10 instruments



70-3524-00  
Perforated Tray



70-3525-00  
Perforated Base



70-3526-00  
Solid Base

**X-Ray Film Holders**



70-450-14



70-450-12



70-450-10



70-450-08



70-450-06



70-450-04



70-450-01



70-451-01



70-452-01

**SMITH**



**SONS**

*Superior Quality Instruments*

Ugoki, Sialkot-51310. Pakistan.  
Email: [info@smithsons.com.pk](mailto:info@smithsons.com.pk)  
Email: [smithsonsinst@gmail.com](mailto:smithsonsinst@gmail.com)  
Web: [www.smithsons.com.pk](http://www.smithsons.com.pk)  
Whatsapp: 0092-347-6588990